

RELAÇÃO DO AÇO

AÇO	N	DIAM (mm)	QUANT	C.UNIT (cm)	C.TOTAL (cm)
CA60	1	5.0	86	77	6622
CA50	2	5.0	74	54	3996
	3	8.0	21	134	2814
	4	8.0	12	114	1368
	5	8.0	12	119	1428
	6	8.0	8	124	992
	7	8.0	11	104	1144
	8	8.0	21	109	2289
	9	8.0	18	94	1692
	10	8.0	30	99	2970
	11	8.0	16	114	1824
	12	8.0	9	89	801
	13	8.0	16	84	1344
	14	8.0	16	89	1424
	15	8.0	14	104	1456
	16	10.0	4	246	984
	17	10.0	4	171	684
	18	10.0	8	236	1888
	19	10.0	24	127	3048
	20	10.0	4	166	664
	21	10.0	6	138	828
	22	10.0	9	108	972
	23	12.5	8	259	2072

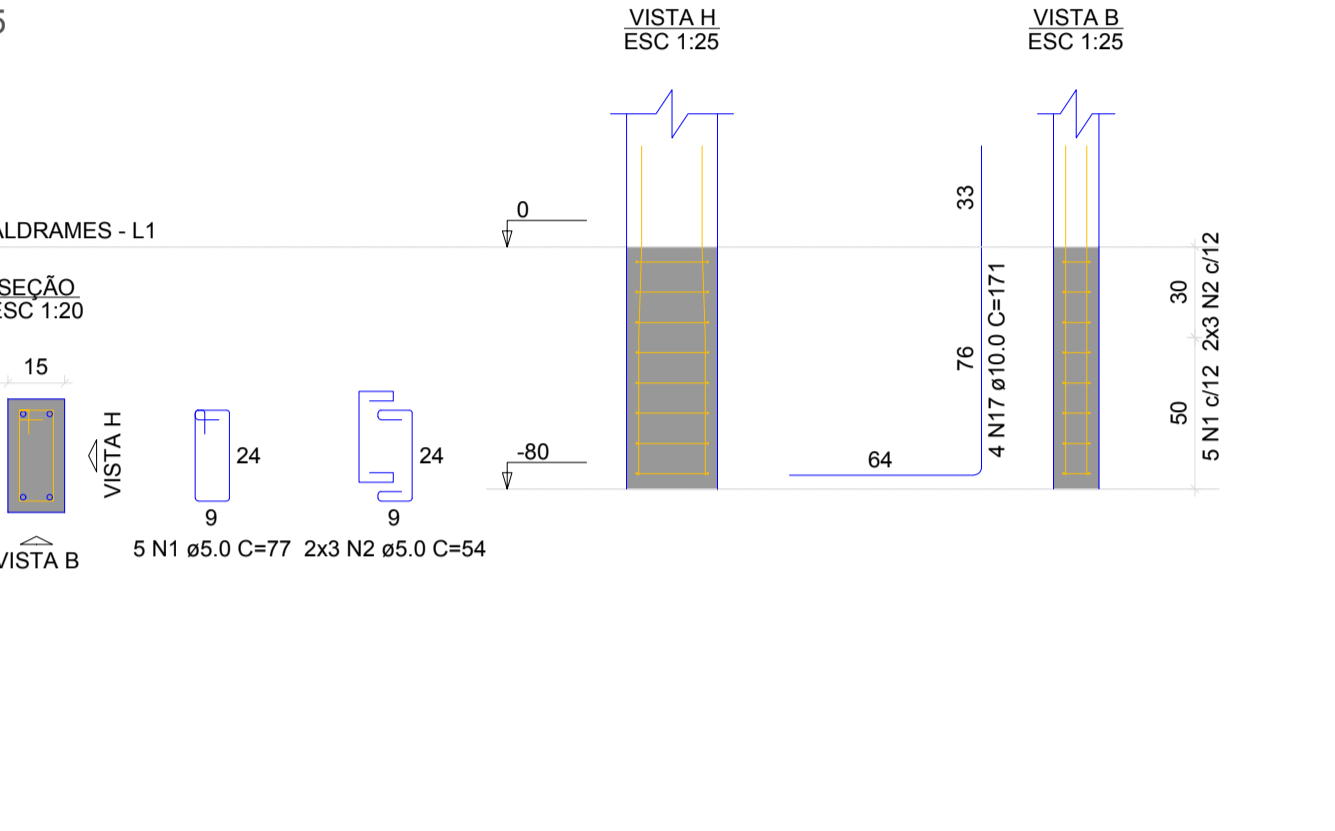
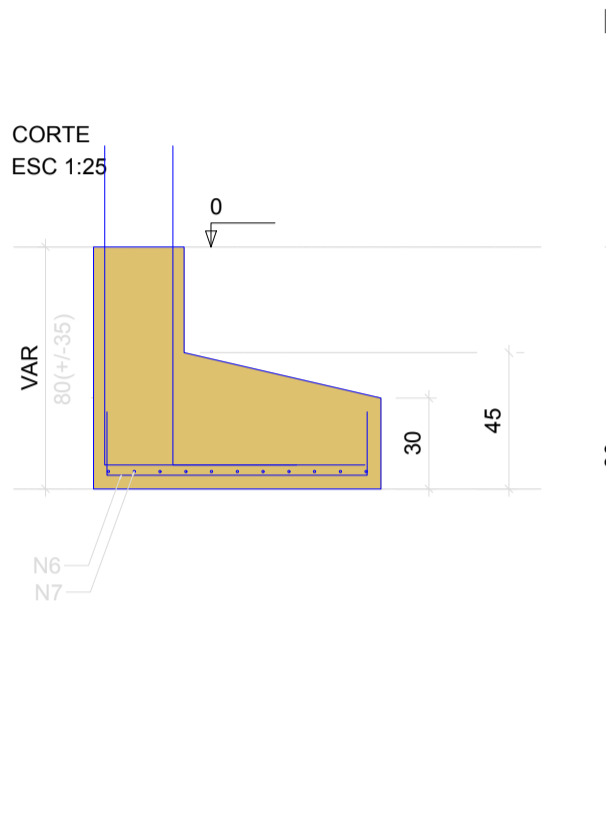
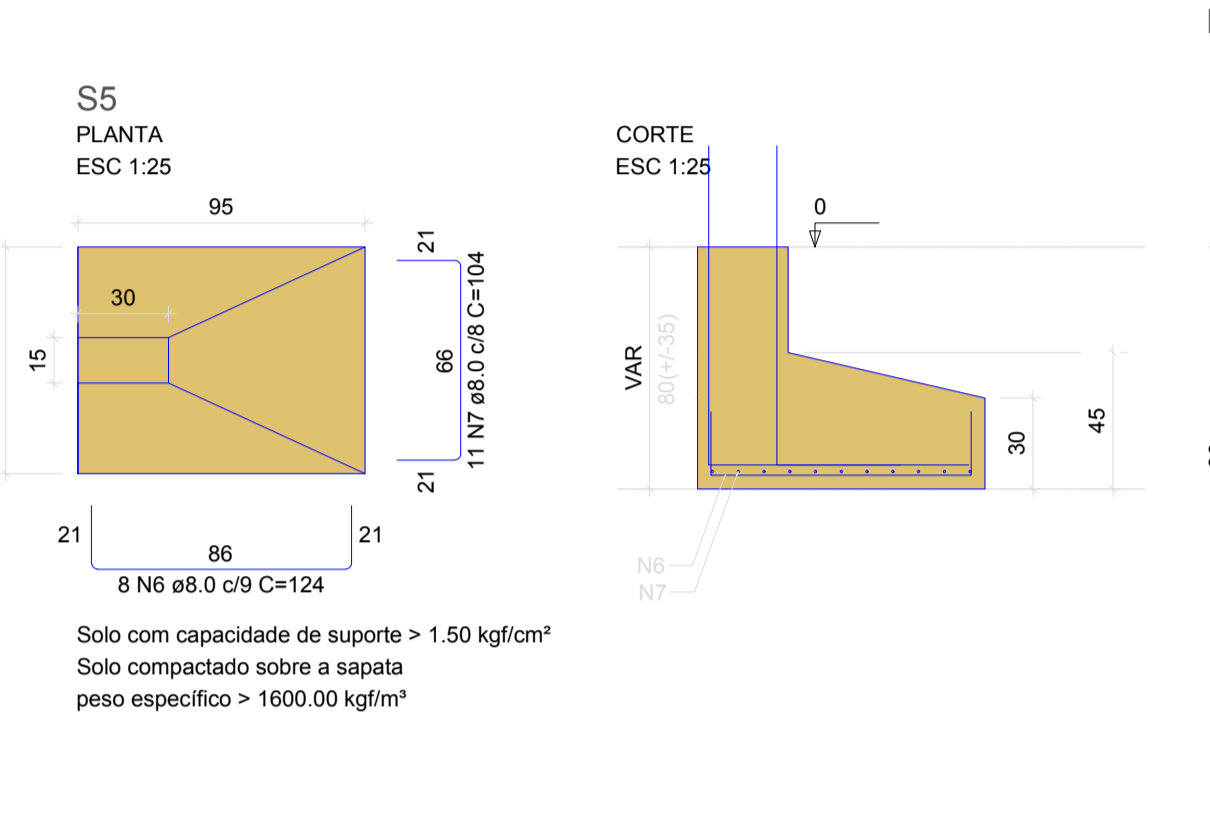
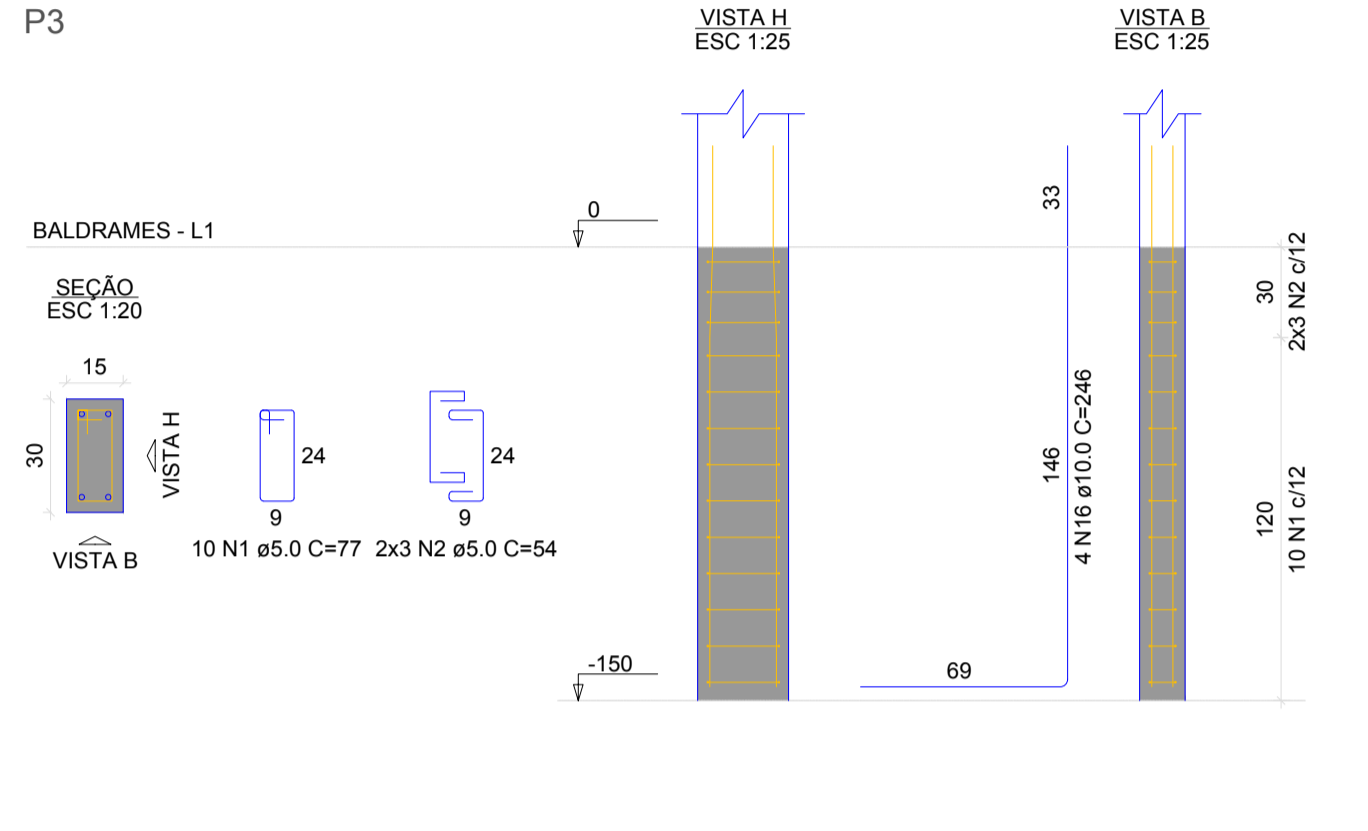
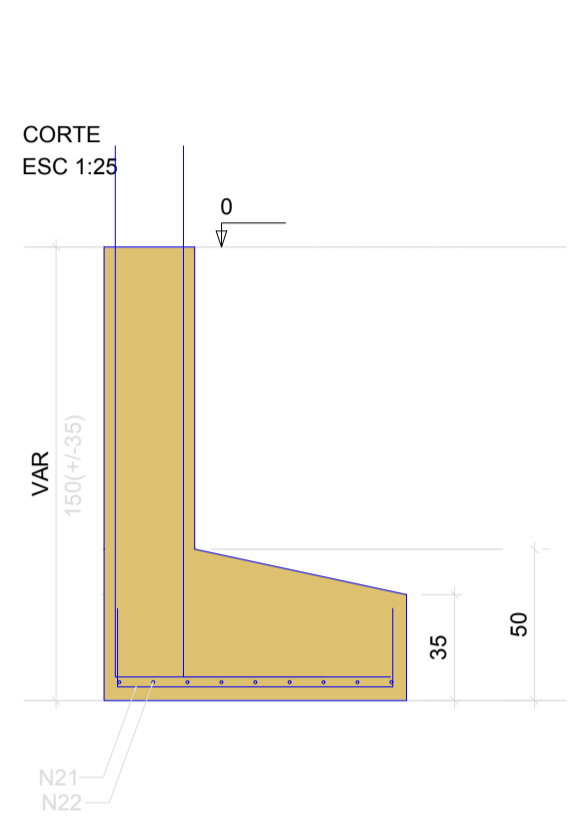
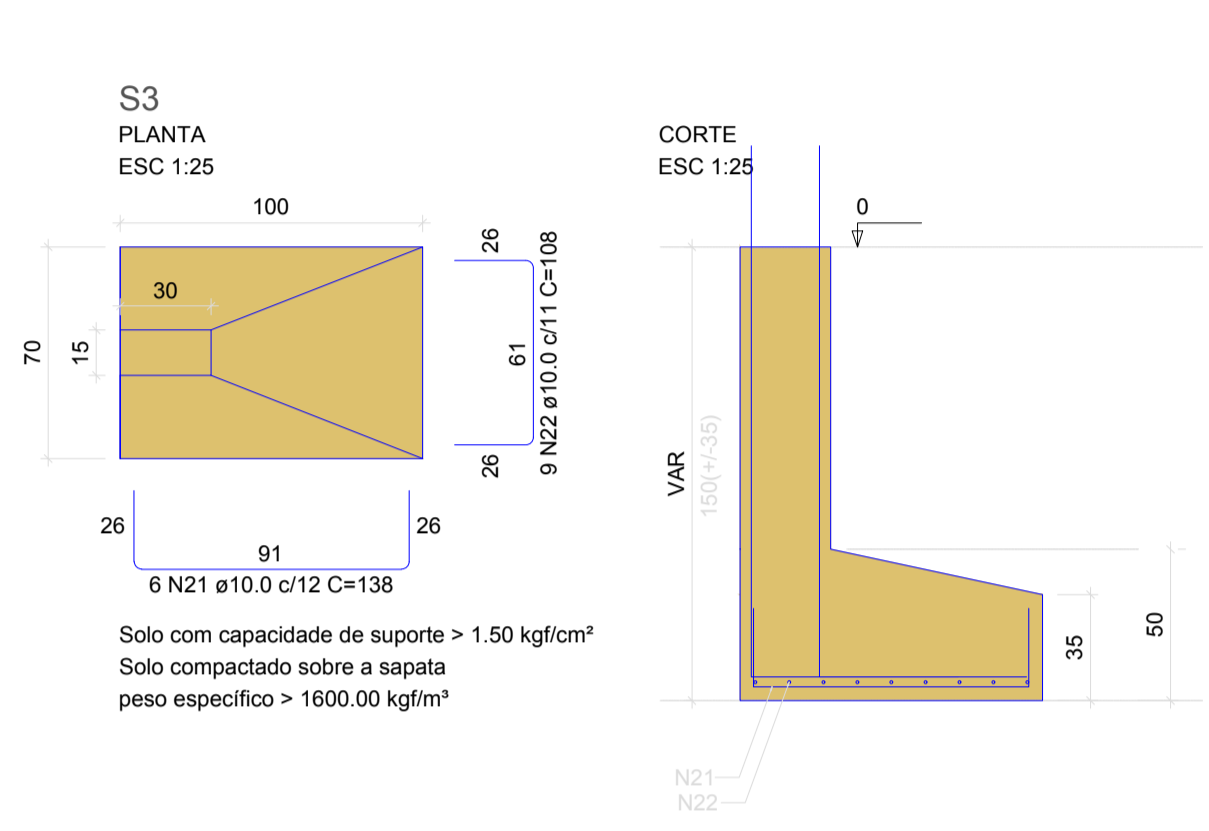

RESUMO DO AÇO

AÇO	DIAM (mm)	C.TOTAL (m)	PESO +10% (kg)
CA50	8.0	215.5	93.5
CA50	10.0	90.7	61.5
CA60	12.5	20.7	22
CA60	5.0	106.2	18
PESO TOTAL (kg)			
CA50	177		
CA60	18		

Volume de concreto (C-30) = 3.53 m³
Área de forma = 19.93 m²

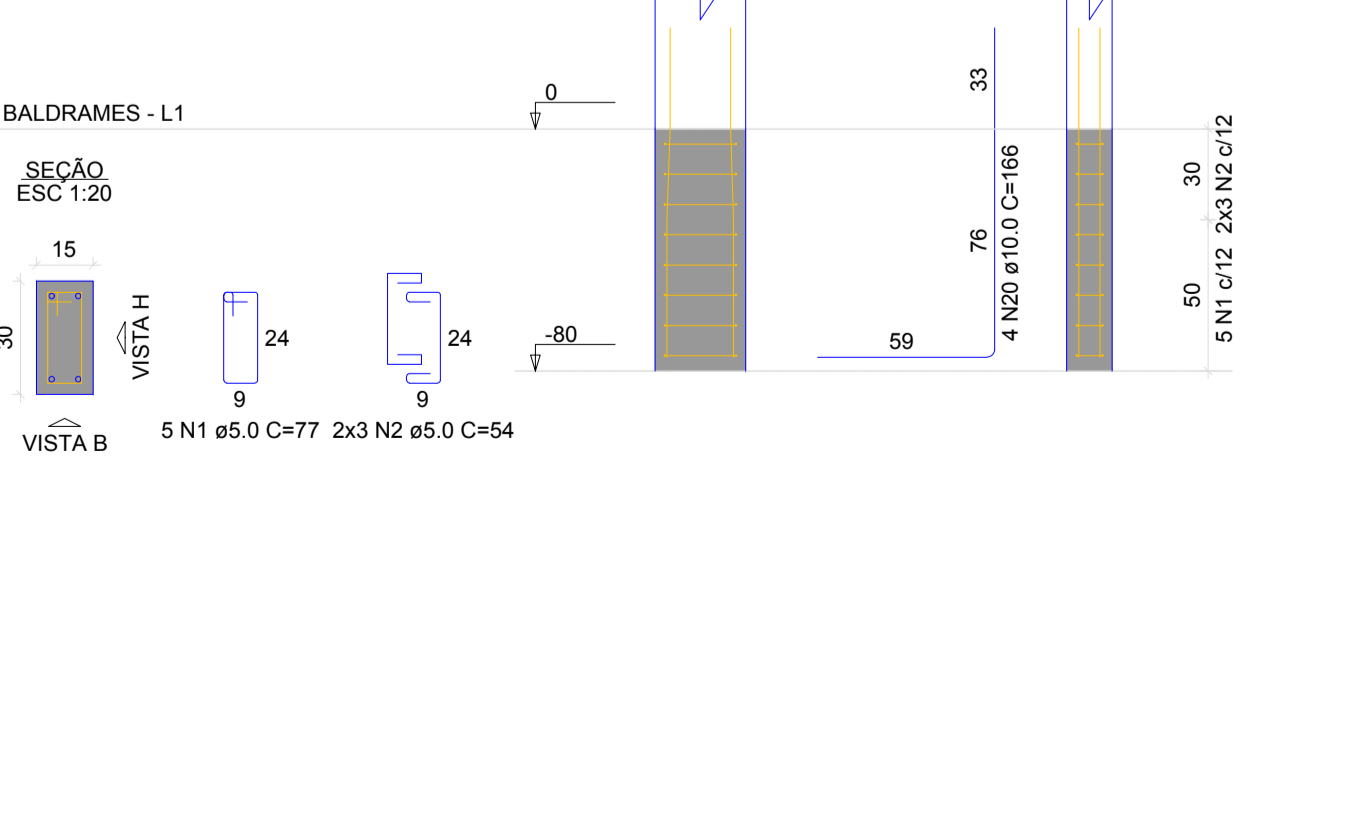
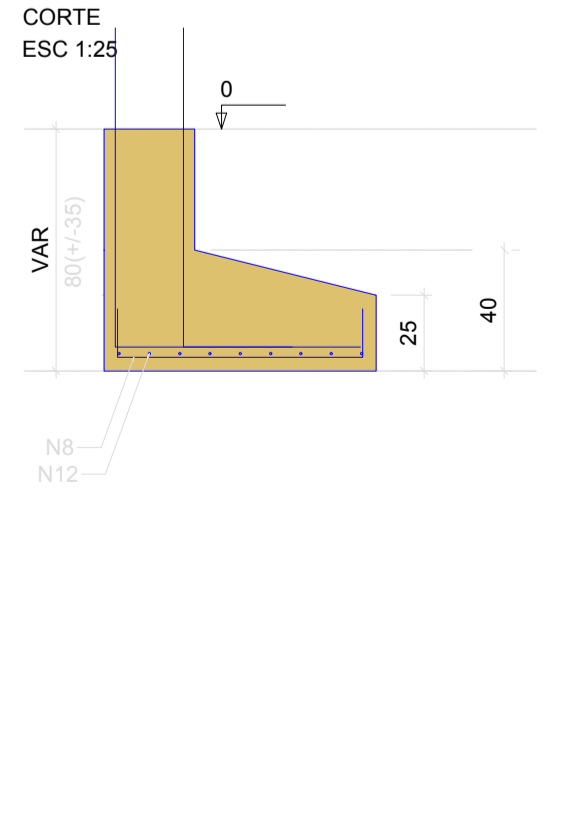
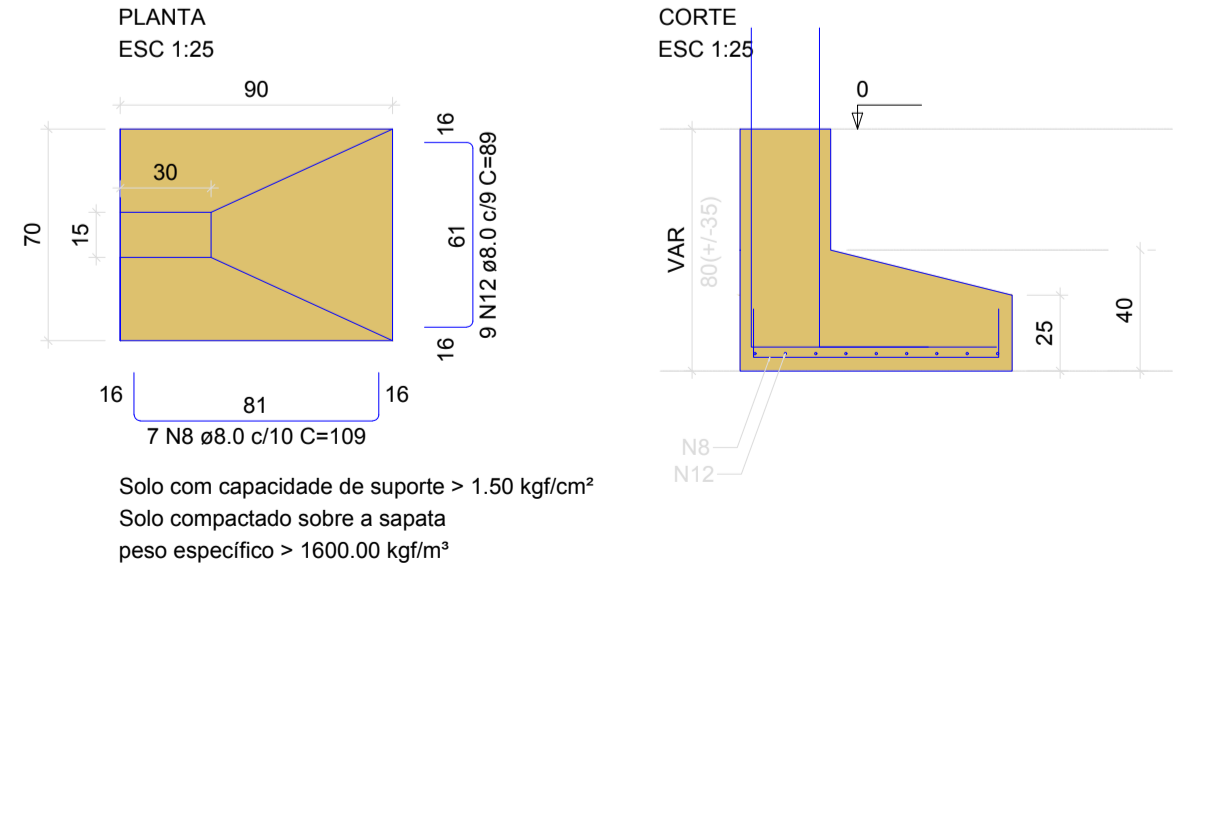
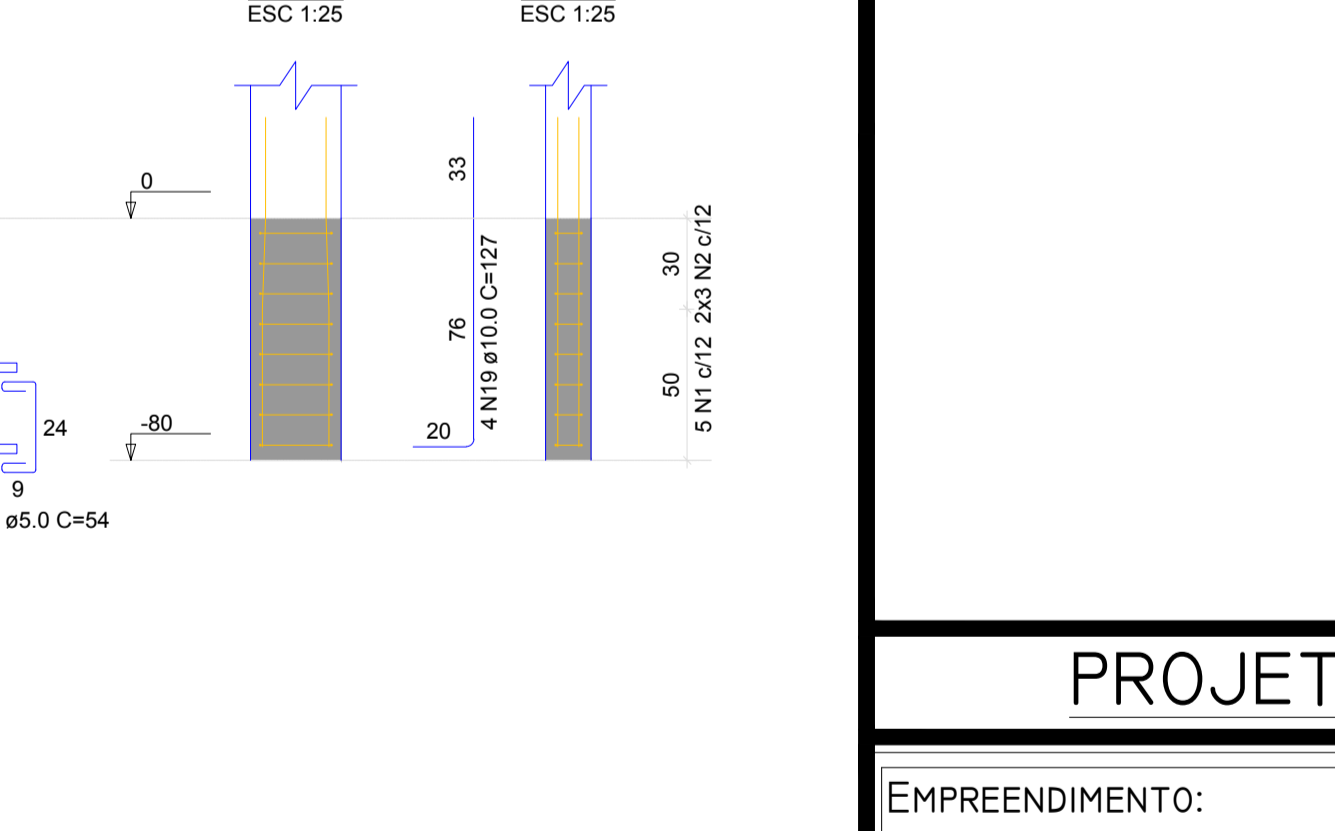
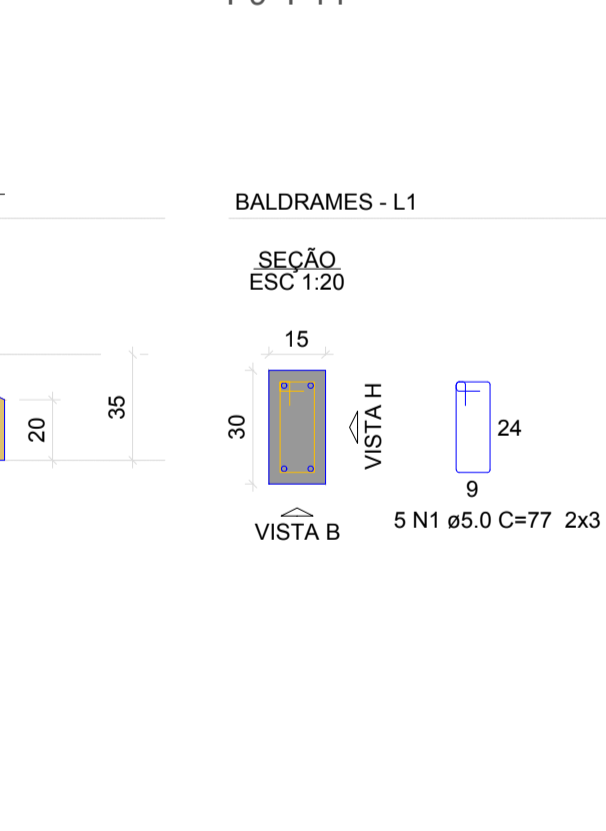
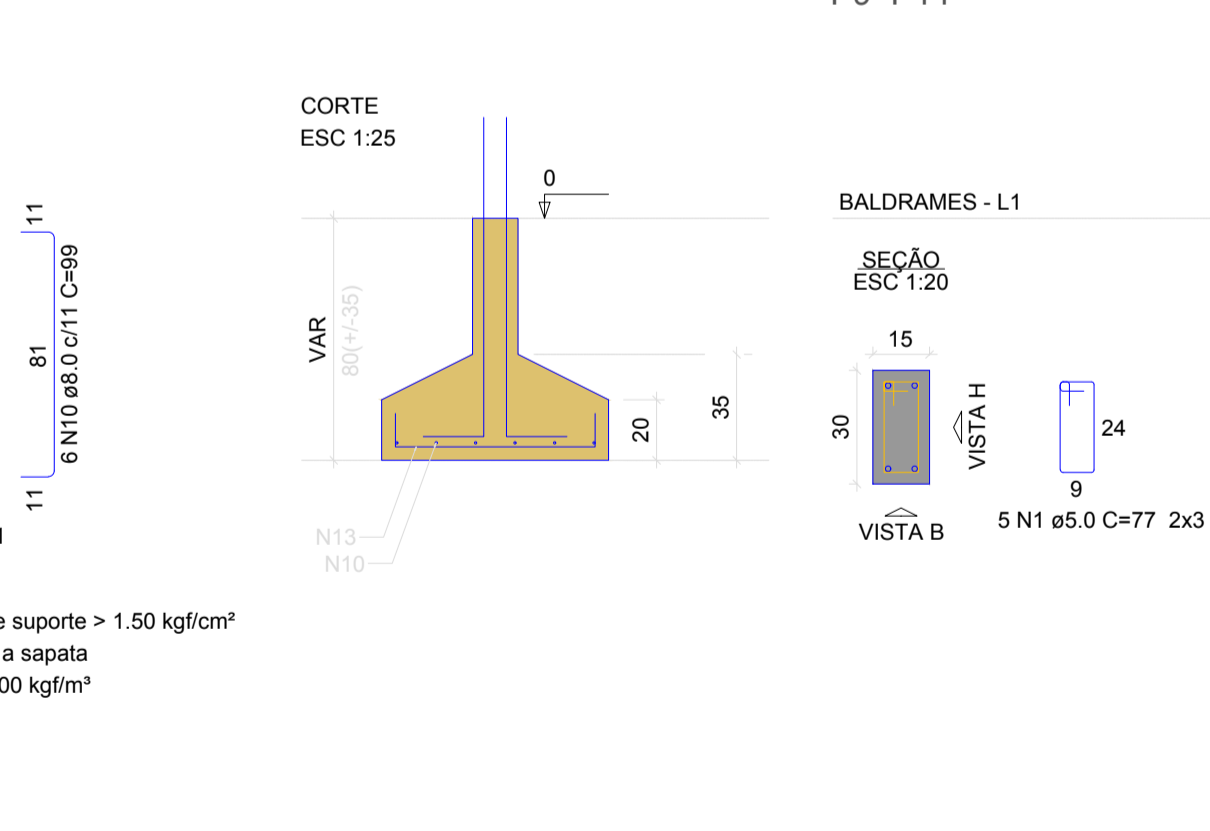
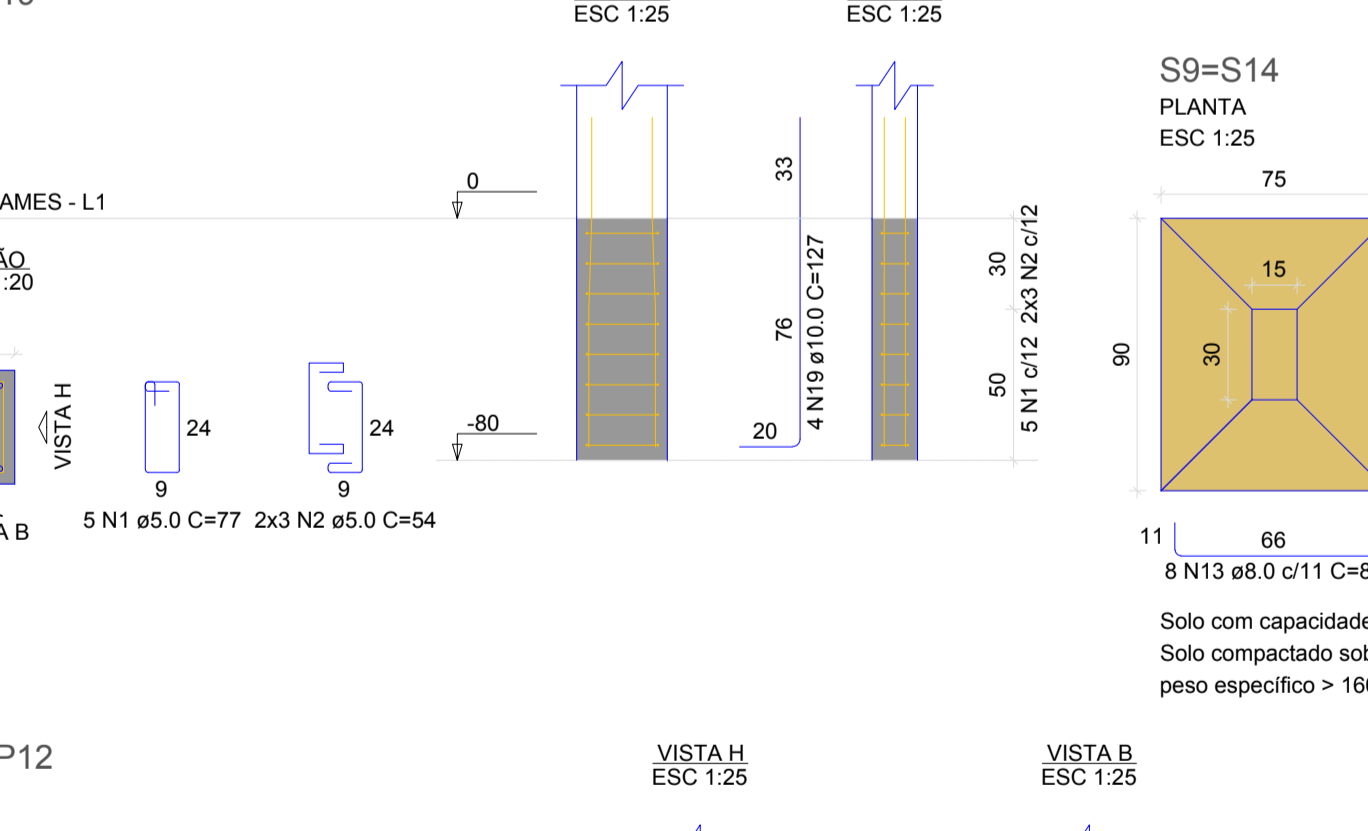
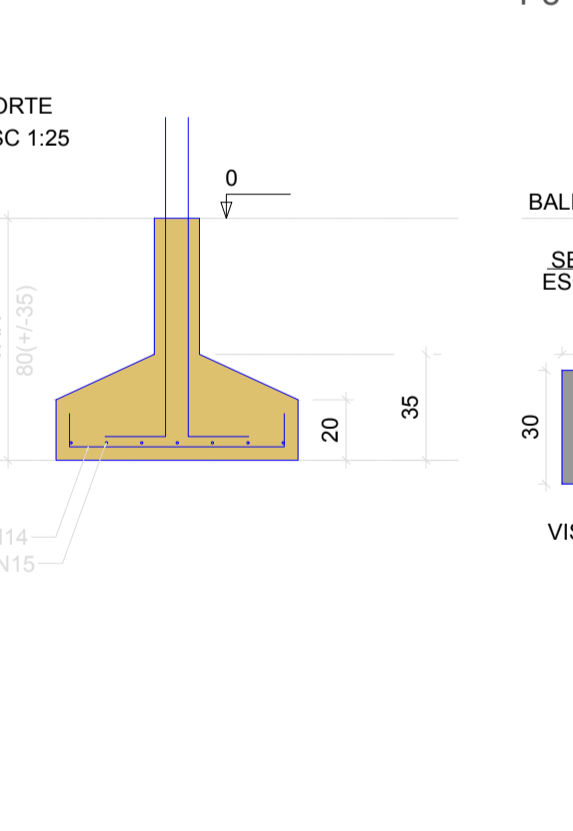
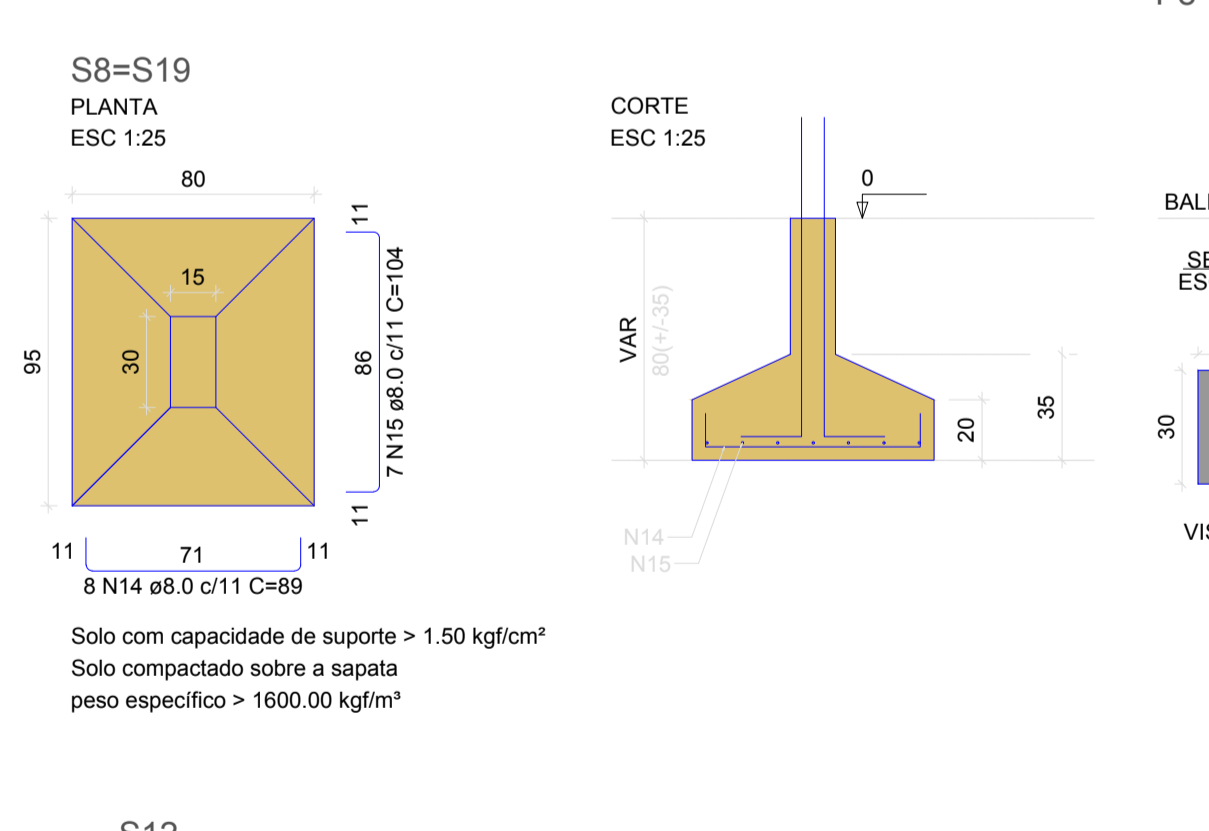
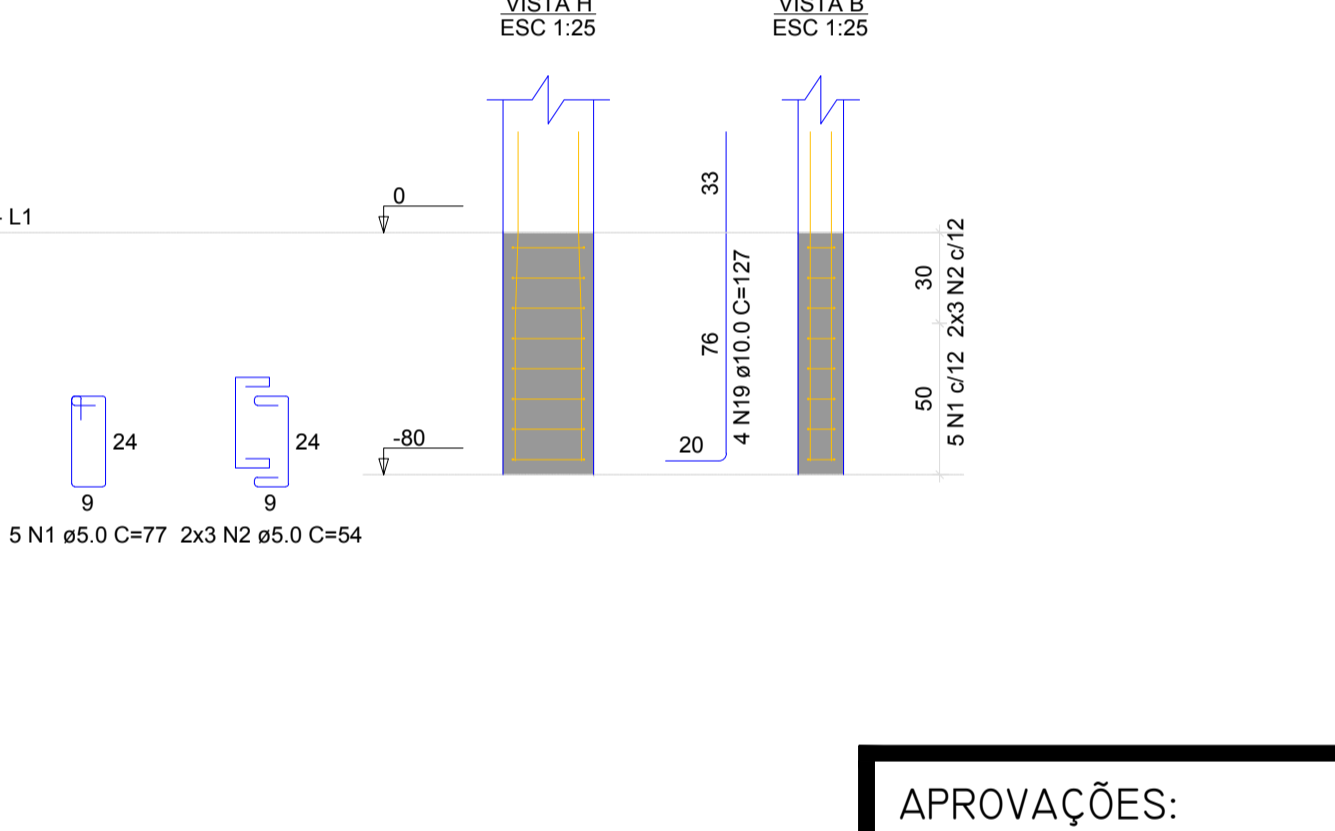
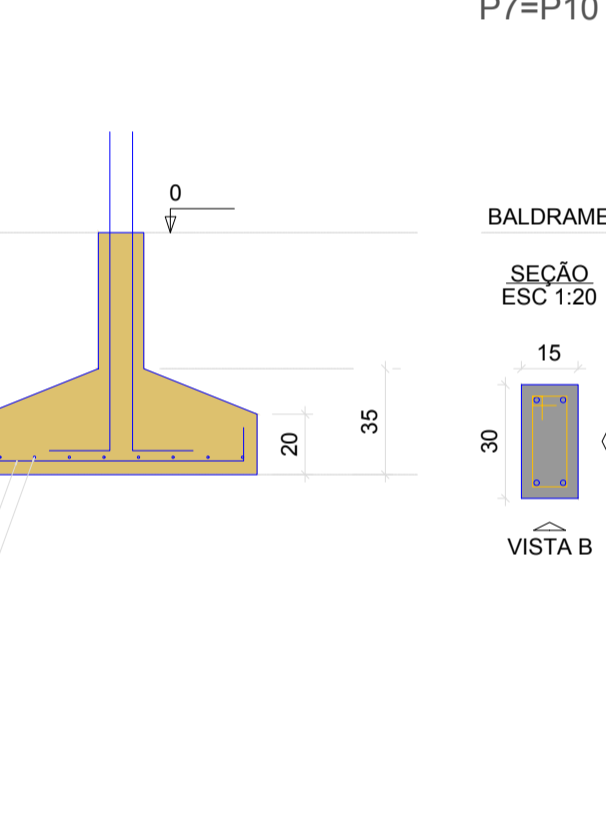
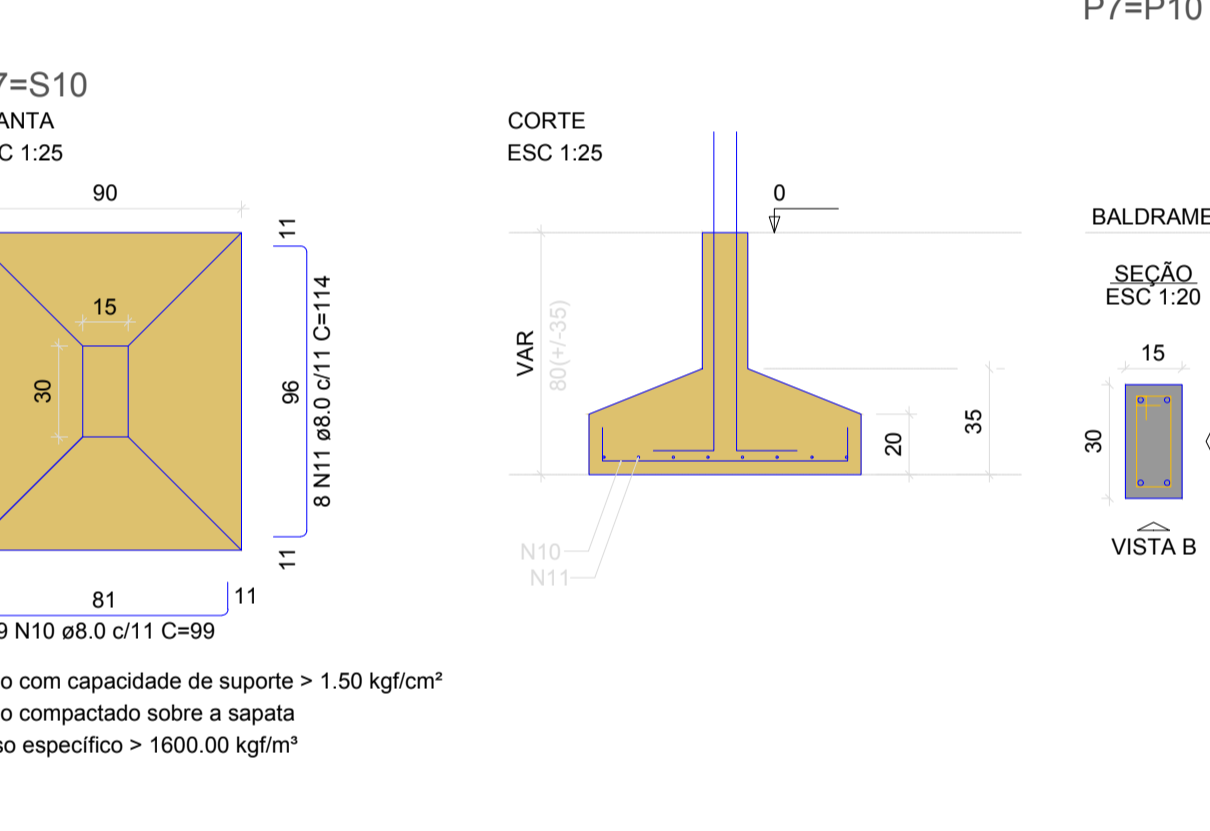
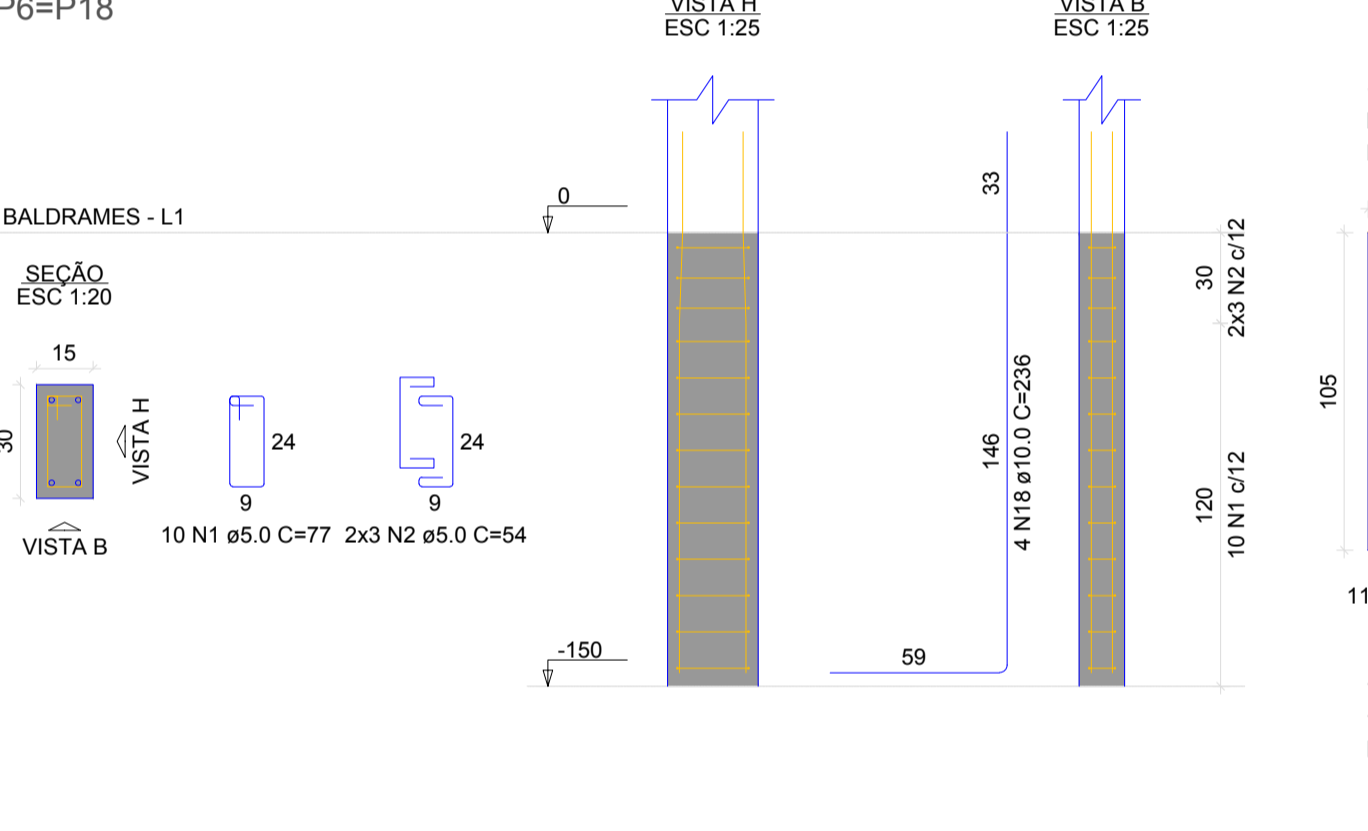
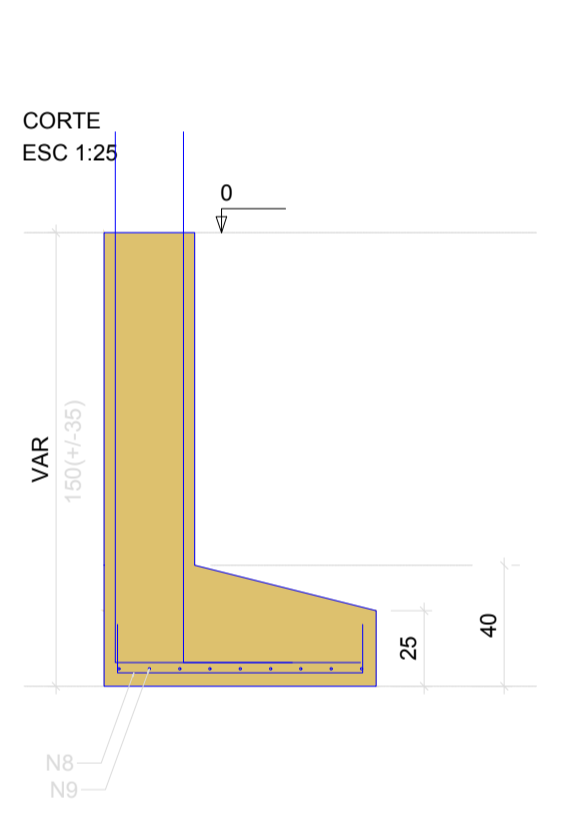
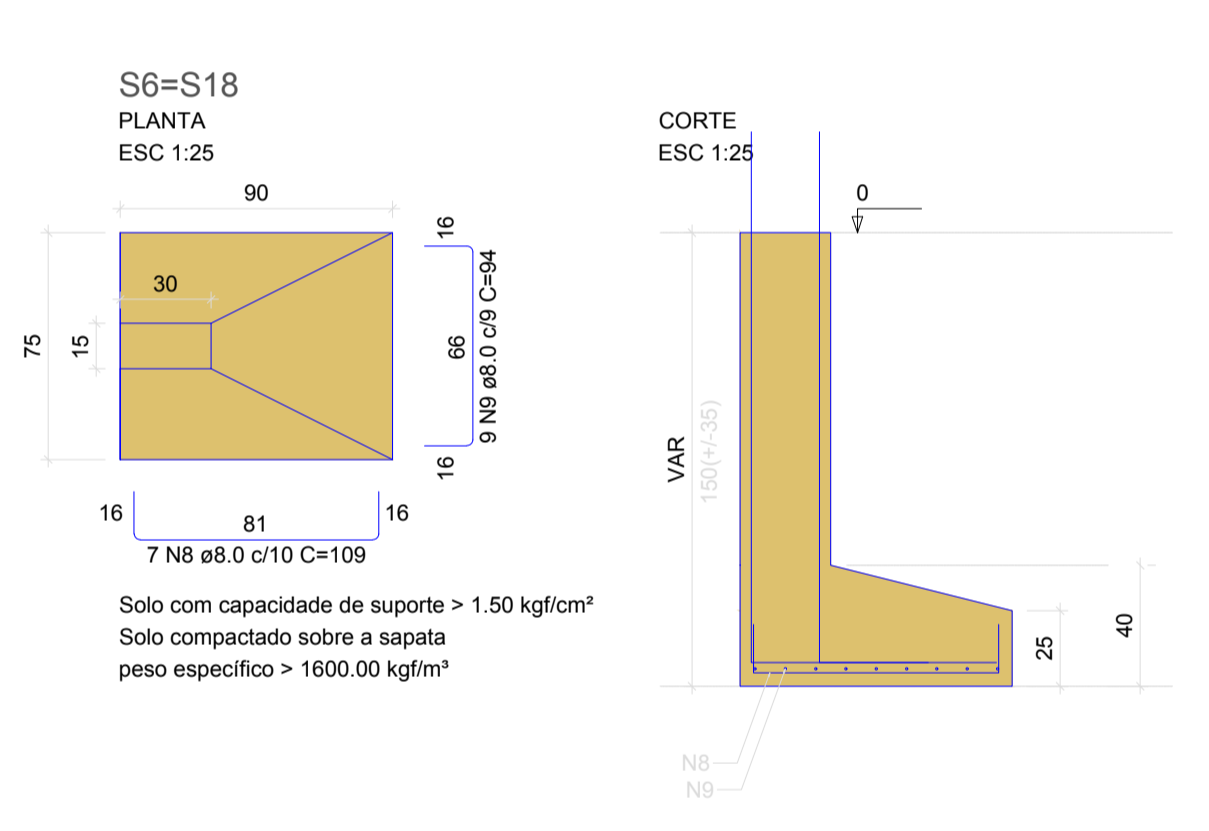

APROVAÇÕES:

PROJETO ESTRUTURAL

EMPREENDIMENTO: ESTRUTURA ESPORTIVA PARA A COMUNIDADE DO ESTRELA VERMELHA

PROPRIETÁRIO: MUNICÍPIO DE BANDEIRANTE/SC
CNPJ: 01.612.528/0001-84

ENDEREÇO: LINHA NOVO ENCANTADO INTERIOR, BANDEIRANTE-SC

RESP. TÉCNICO: GIOVANE MIGUEL KUHN
CREA-SC 186.990-8

CONTEÚDO: (GALPÃO)

SAPATAS

FOLHA **EST 108**

ESCALA: COMO INDICADO

DATA: FEV/26

DESENHO: GIOVANE KUHN