

San. Infantil Iraldário
Escala: 1:25

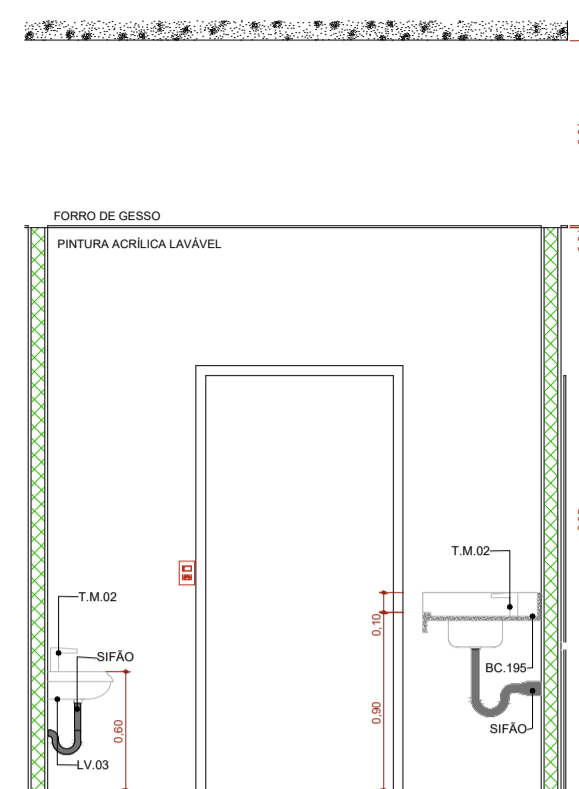

San. Infantil Iraldário VISTA 1
Escala: 1:25

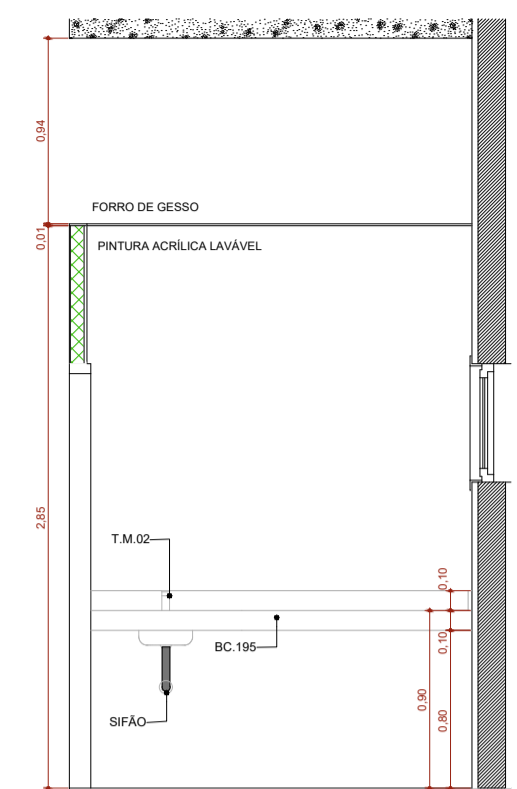

San. Infantil Iraldário VISTA 2
Escala: 1:25

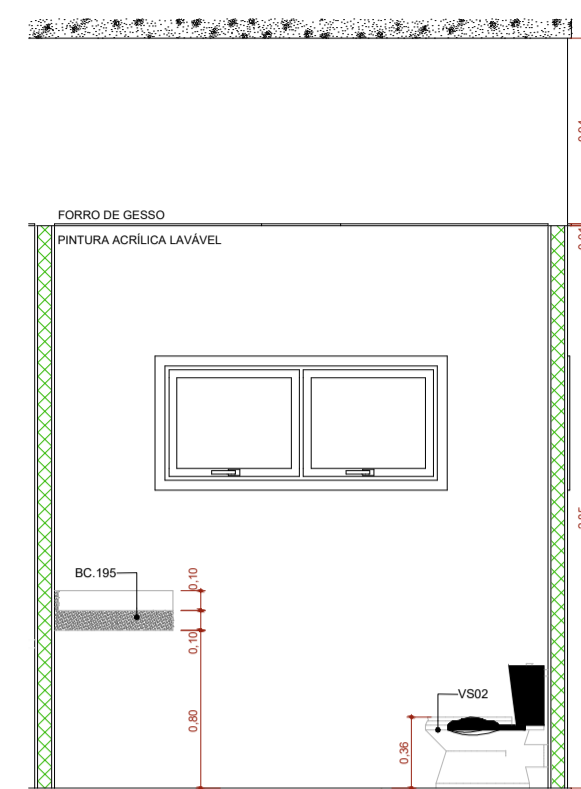

San. Infantil Iraldário VISTA 3
Escala: 1:25

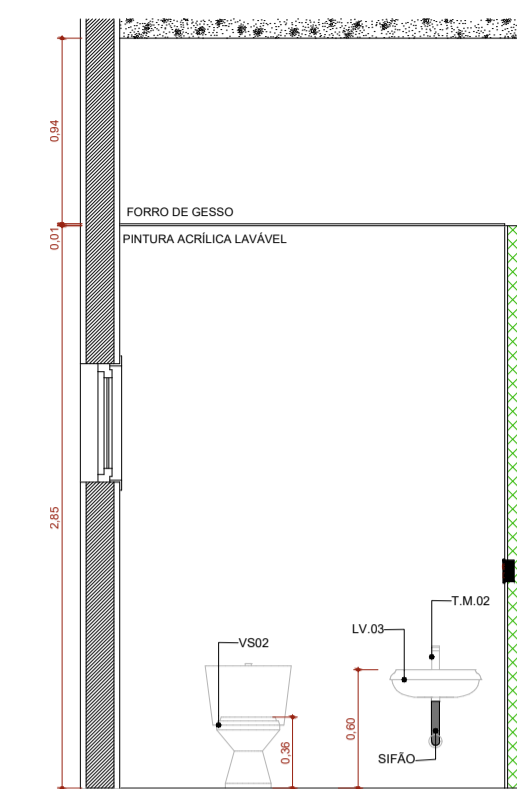

San. Infantil Iraldário VISTA 4
Escala: 1:25

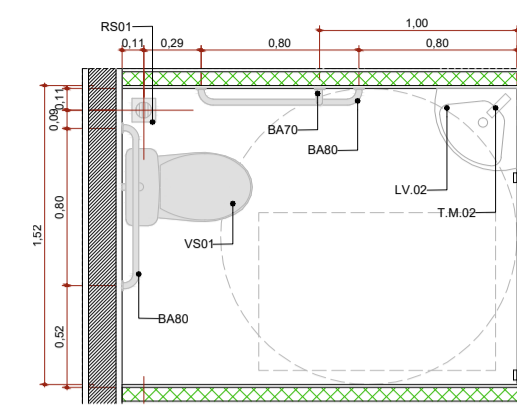

San. PCD
Escala: 1:25

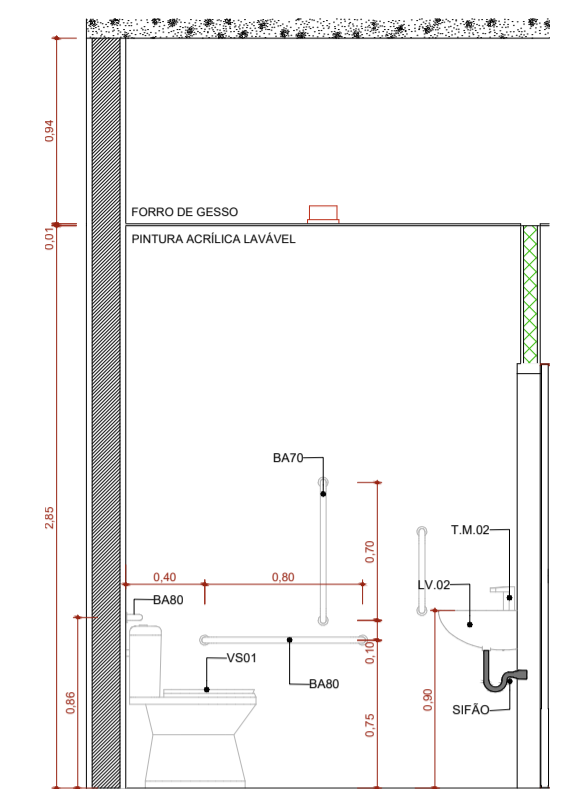

San. PCD VISTA 1
Escala: 1:25

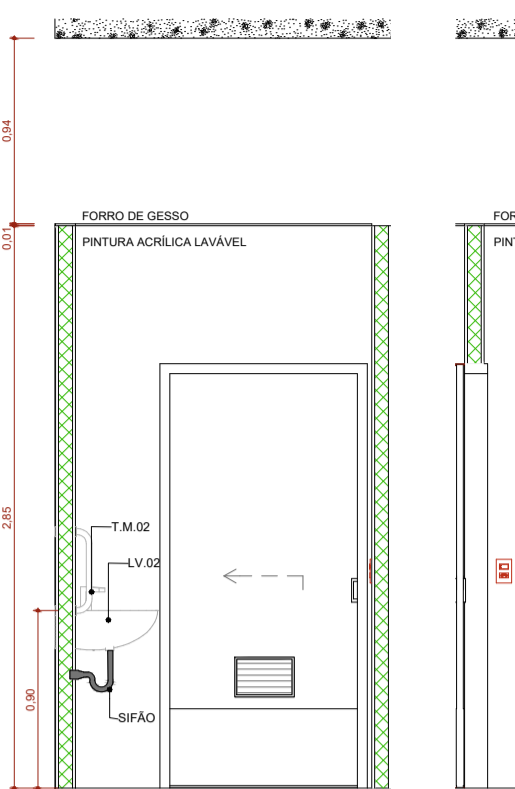

San. PCD VISTA 2
Escala: 1:25

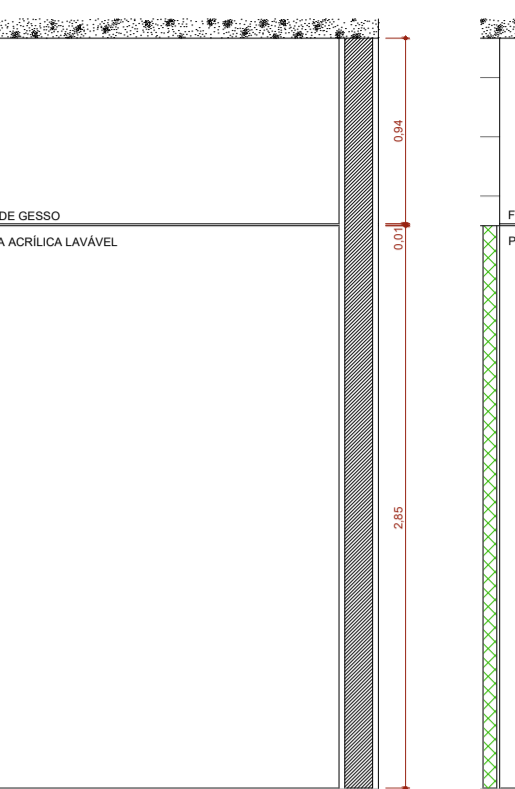

San. PCD VISTA 3
Escala: 1:25

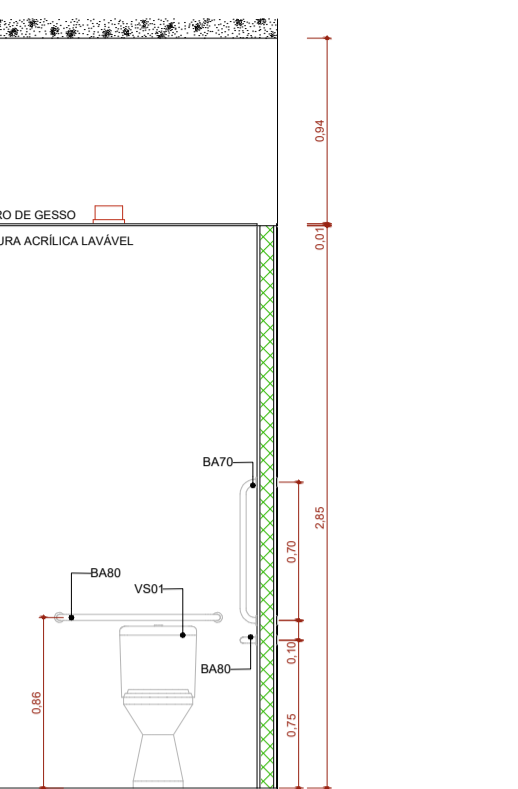

San. PCD VISTA 4
Escala: 1:25

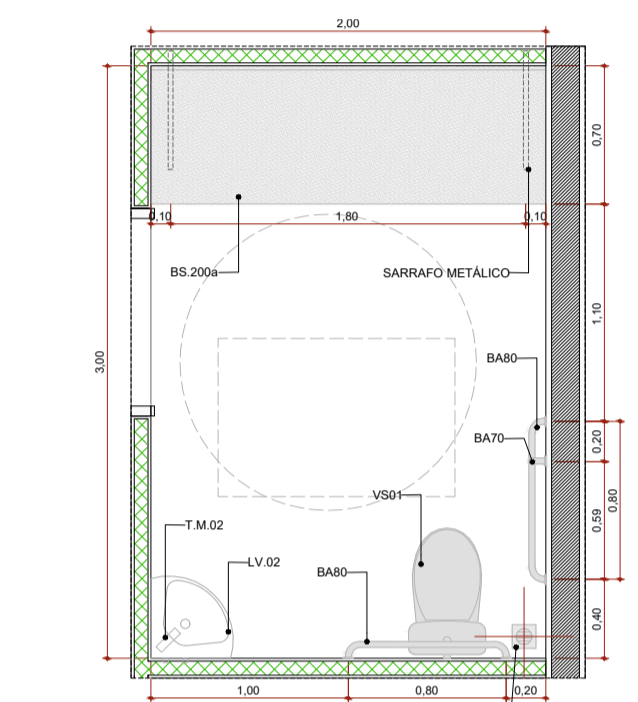

San. Familiar
Escala: 1:25

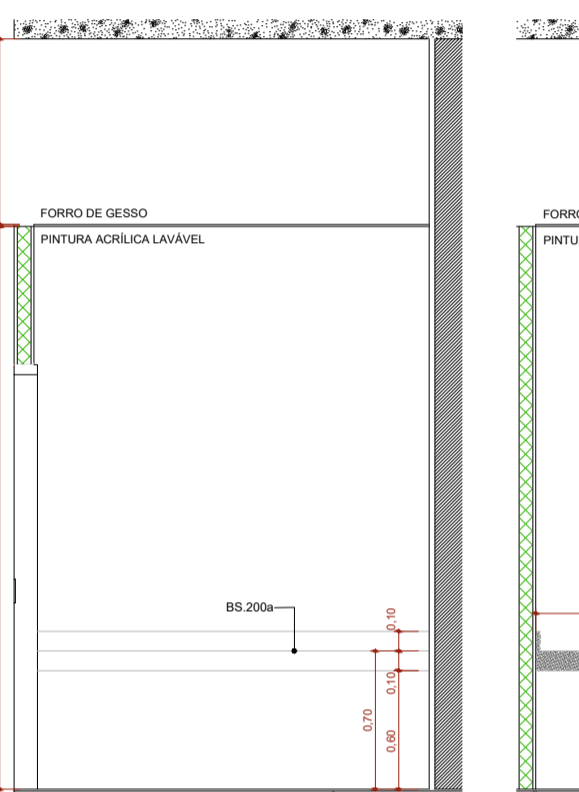

San. Familiar VISTA 1
Escala: 1:25

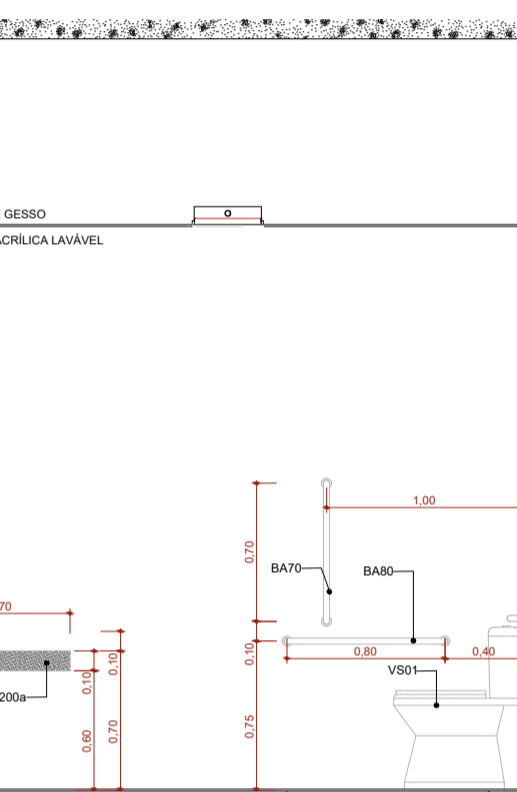

San. Familiar VISTA 2
Escala: 1:25

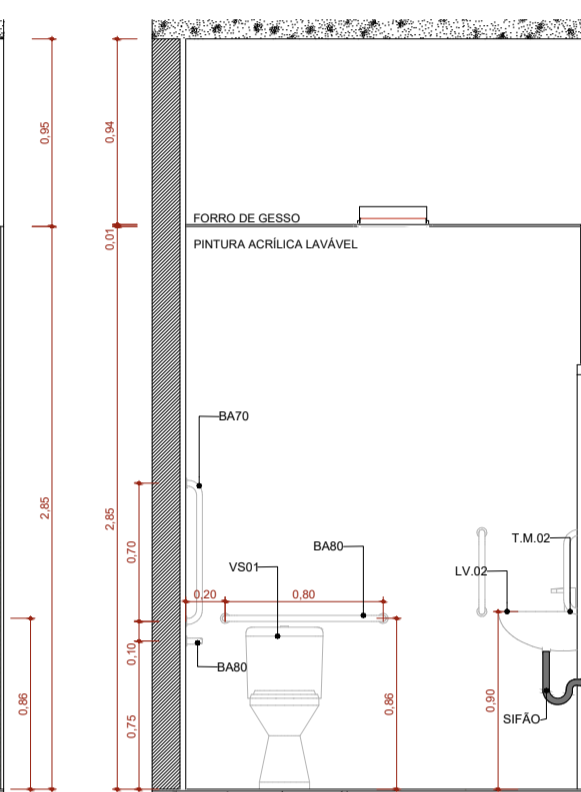

San. Familiar VISTA 3
Escala: 1:25

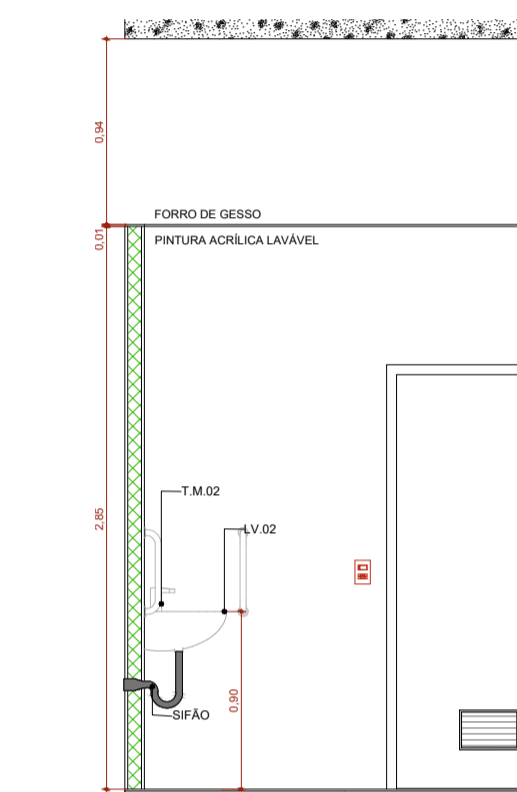

San. Familiar VISTA 4
Escala: 1:25

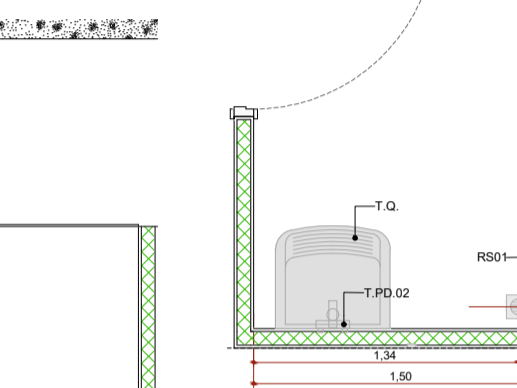

DML
Escala: 1:25

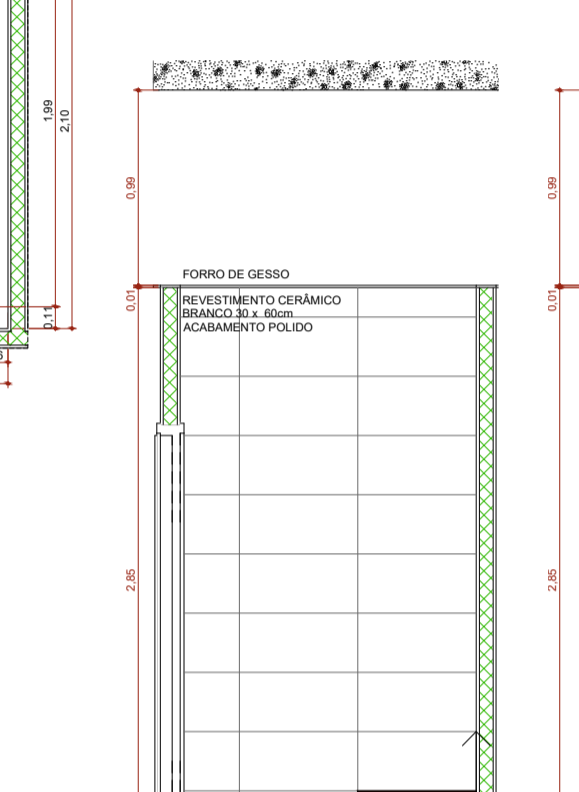

DML VISTA 1
Escala: 1:25

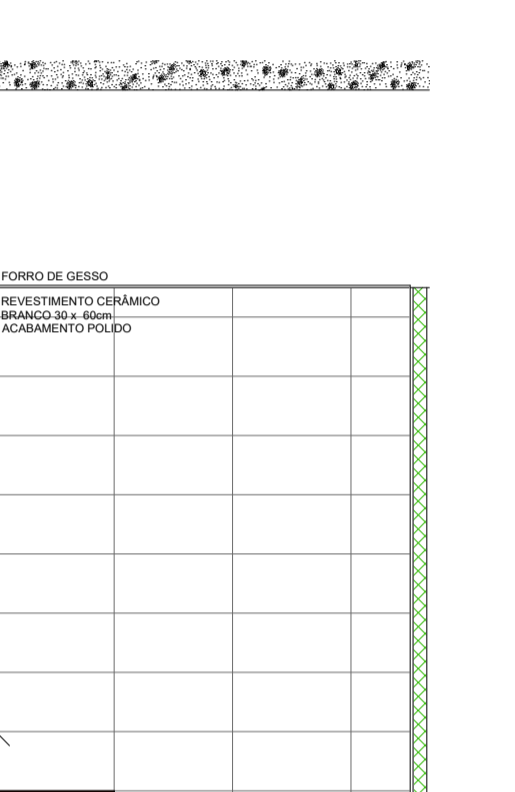

DML VISTA 2
Escala: 1:25

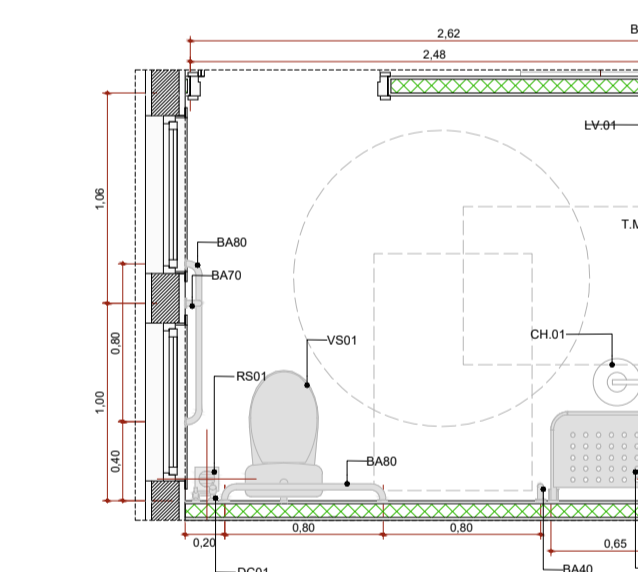

Ban. Quartos Internação
Escala: 1:25

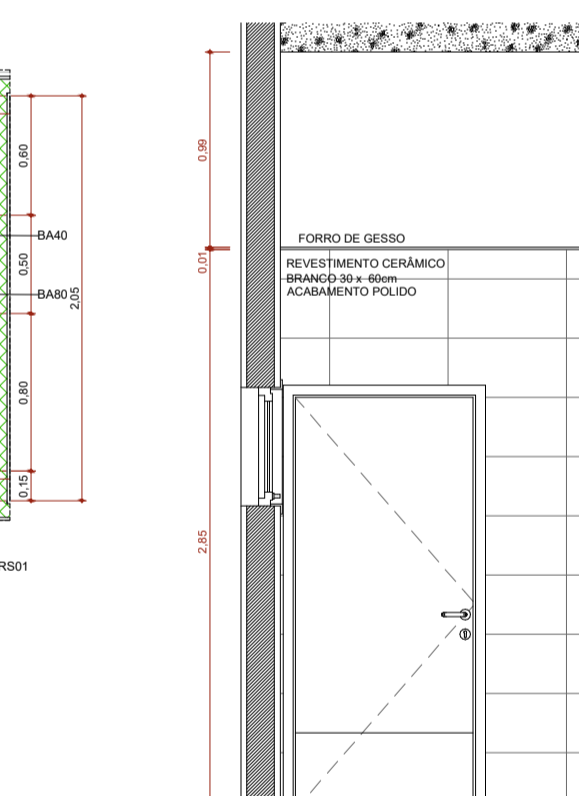

Ban. Quartos Internação VISTA 1
Escala: 1:25

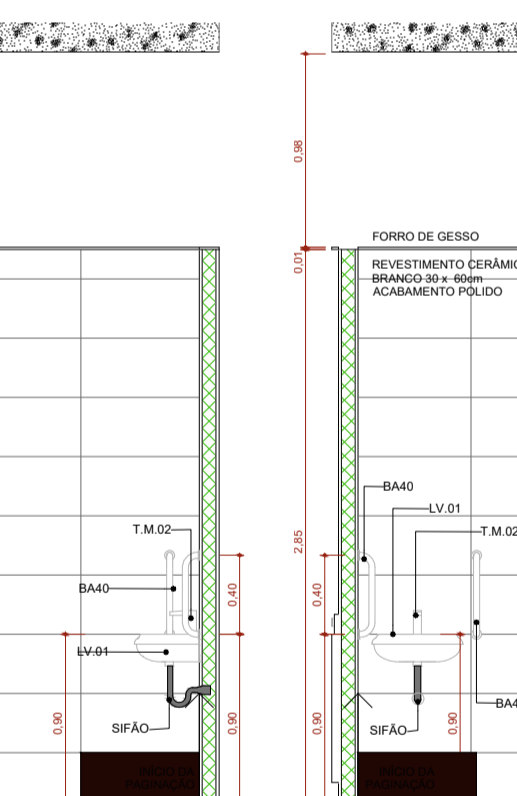

Ban. Quartos Internação VISTA 2
Escala: 1:25

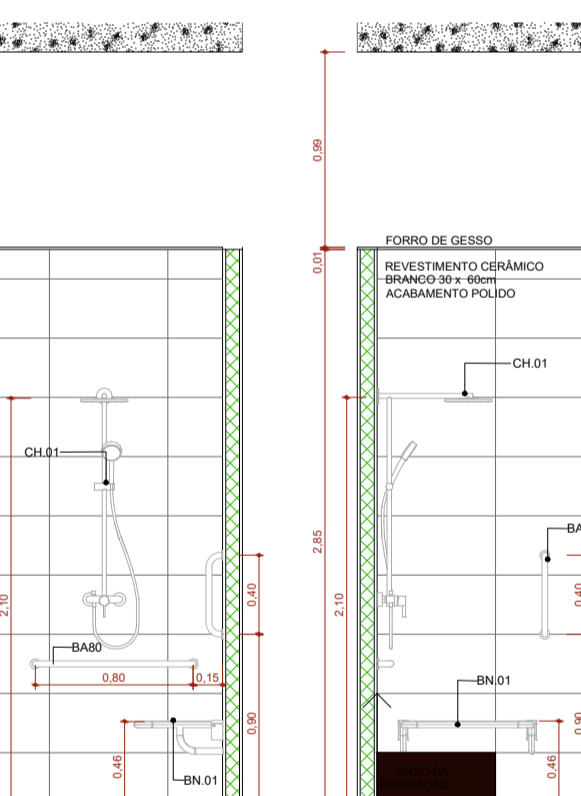

Ban. Quartos Internação VISTA 3
Escala: 1:25

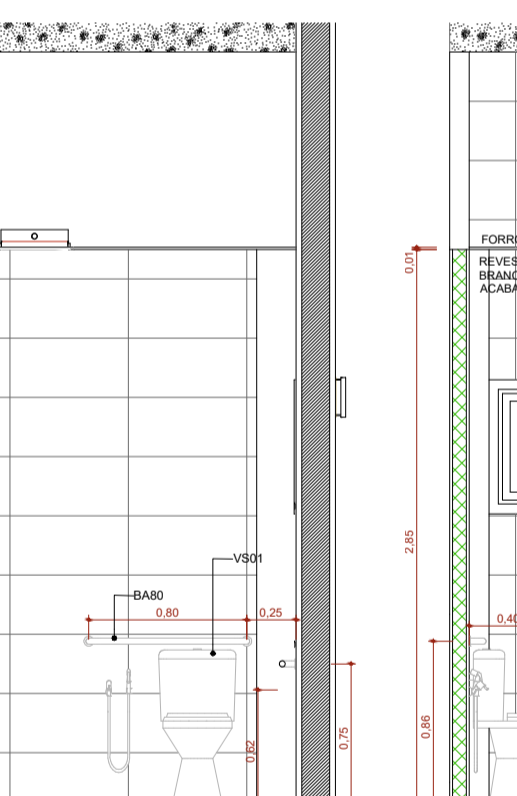

Ban. Quartos Internação VISTA 4
Escala: 1:25

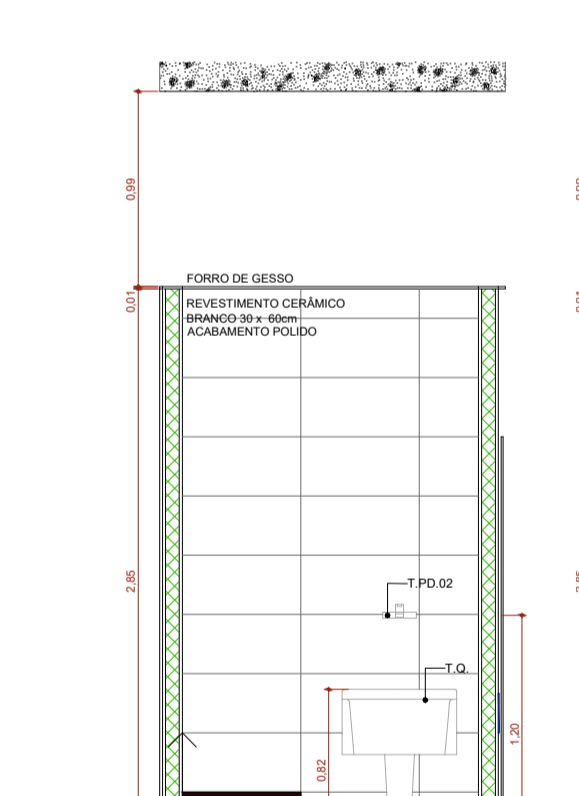

DML VISTA 3
Escala: 1:25

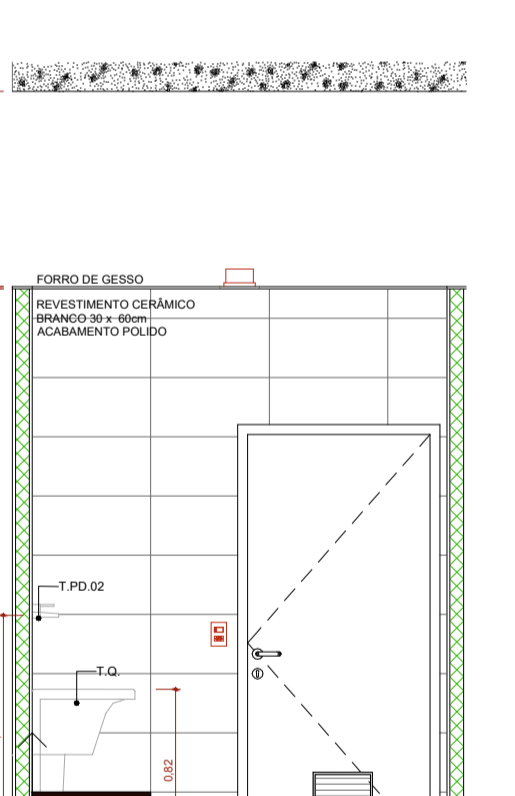

DML VISTA 4
Escala: 1:25

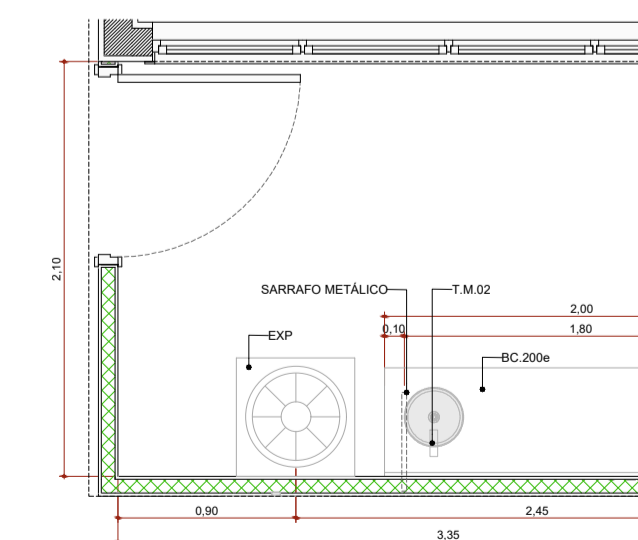

Sala de Utilidades
Escala: 1:25

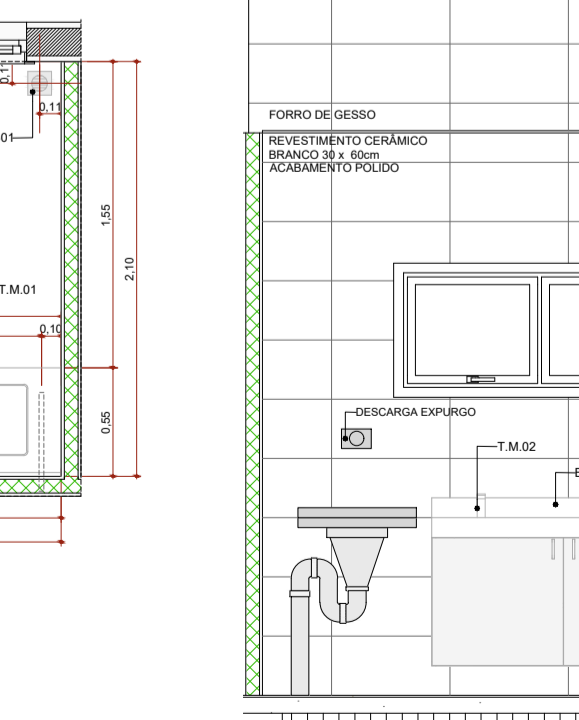

Sala de Utilidades VISTA 1
Escala: 1:25

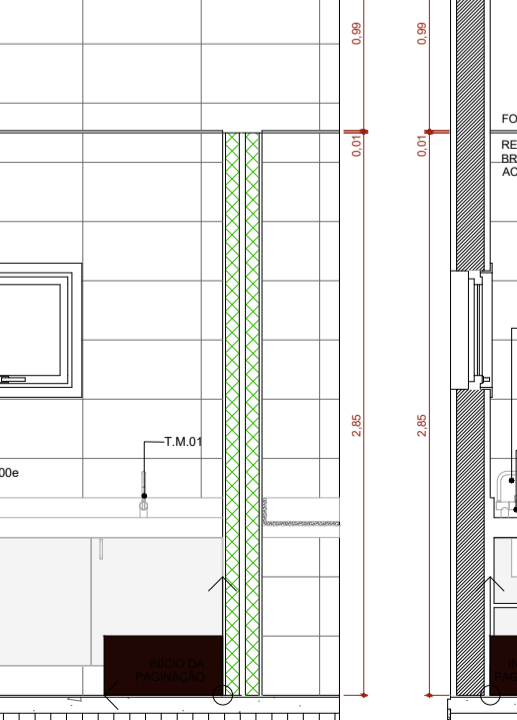

Sala de Utilidades VISTA 2
Escala: 1:25

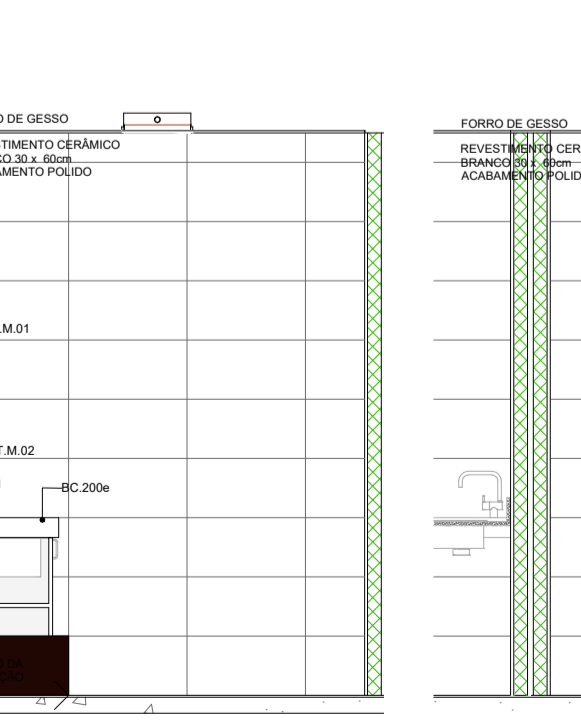

Sala de Utilidades VISTA 3
Escala: 1:25

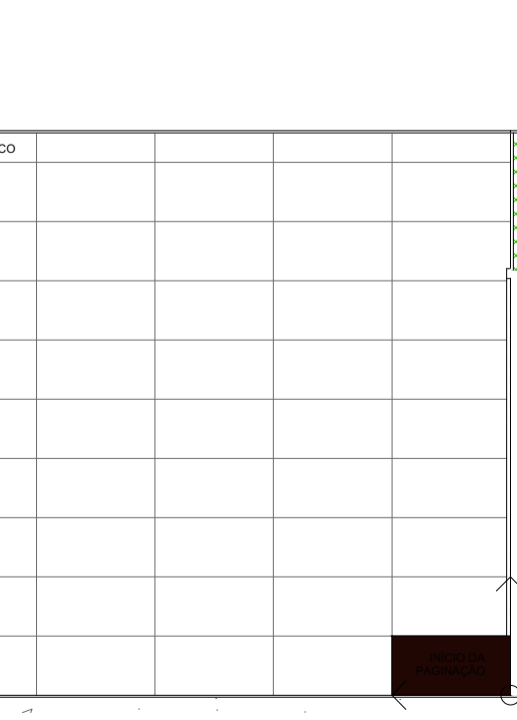

Sala de Utilidades VISTA 4
Escala: 1:25

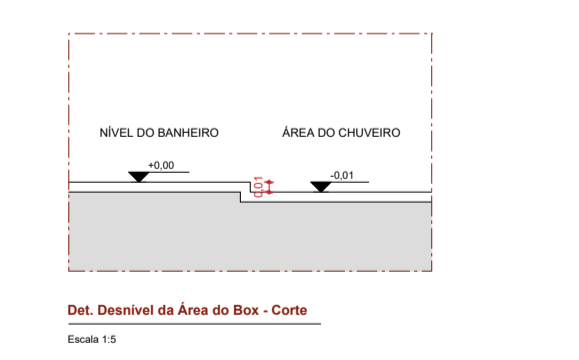

Det. Detalhe da Área do Box - Corte
Escala: 1:5



AUTOR (A) DO PROJETO EXECUTIVO RENY MOITA PORTO		REGISTRO CAU: A163950-1BR
AUTOR (A) DO PROJETO EXECUTIVO VIVIANE KELLI MACHADO		REGISTRO CAU: A38938 - 2
AUTOR (A) DO PROJETO EXECUTIVO DANIELA MENEZES EMILIANO		REGISTRO CAU: A253522-0
AUTOR (A) DO PROJETO EXECUTIVO BARBARA MOREIRA RIBEIRO		REGISTRO CREA: 7968

		Unidade Gestora de Projetos Especiais
OBJETO MATERNIDADE TIPO II PROPRIETÁRIO FUNDO ESTADUAL DE SAÚDE - FES		DISCIPLINA ARQUITETURA PRANCHA 29/43
ENDEREÇO AV. TORQUATO TAPAJÓS, S/N, BAIRRO COLÔNIA TERRA NOVA, MANAUS-AM		
TÍTULO DA PRANCHA DETALHAMENTO ÁREAS MOLHADAS		DESCRIÇÃO DA ETAPA PROJETO EXECUTIVO
NOME: PRANCHA-ARQUIVO MS_MAT2_PE_AQ_29	REVISÃO R4	
AUTOR(A) INTELCTUAL MIRELA PILON PESSATTI SIMONE ALVES PRADO MENEZES VICTORIA ANGELI CAPOVILLA		DATA 03/09/2025
REGISTRO CAU - 25669-2 CAU - 36015-5 CAU - 247156-6		ESCALA INDICADA
DIREITOS AUTORAIS RESERVADOS CONFORME LEGISLAÇÃO NACIONAL E INTERNACIONAL		FOLHA Nº 84,10x59,40

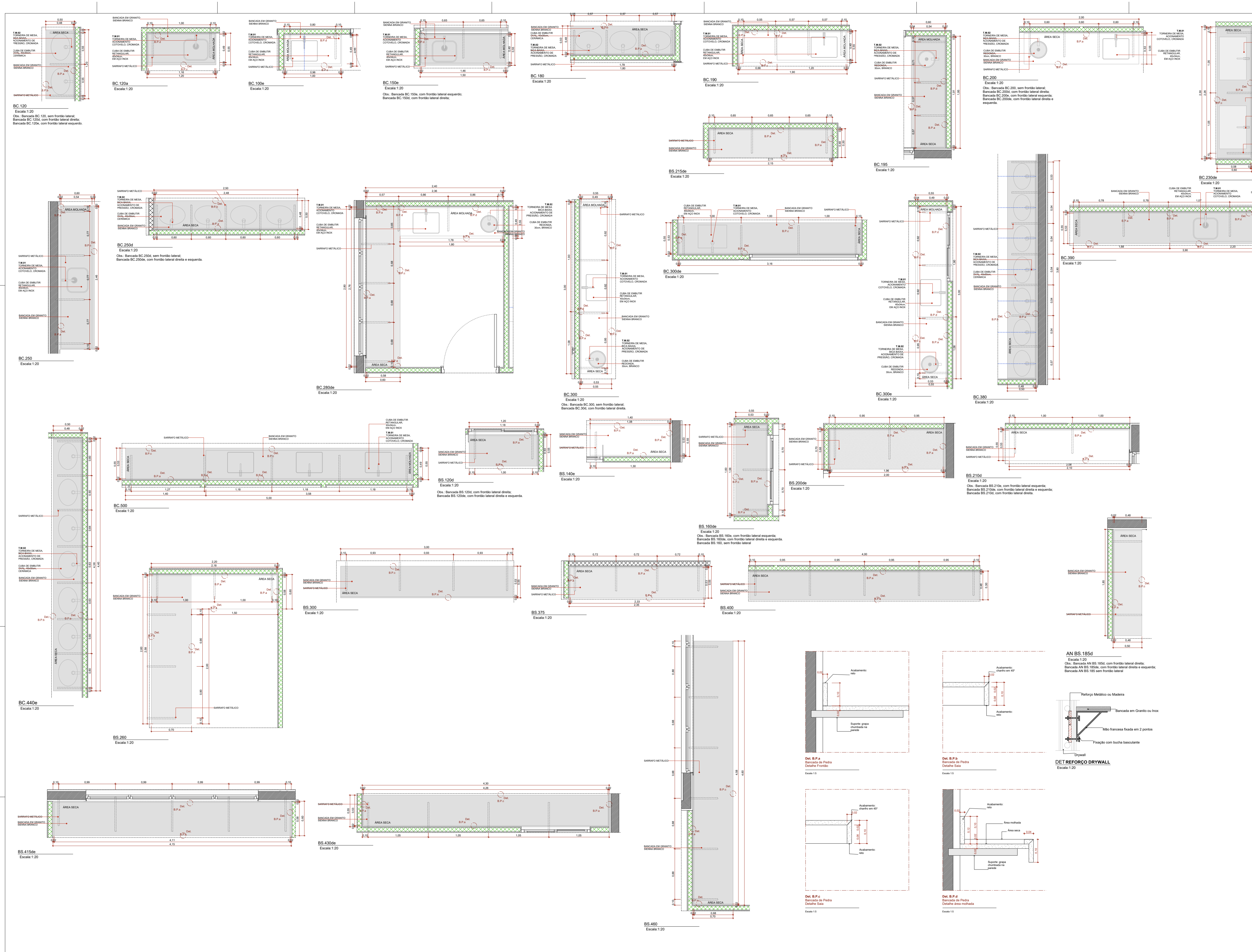

REVISAO	ALTERACAO	DATA
R02	CORRECCAO DA NOTA VISITARIO	24/09/2024
R04	CORRECCAO DO NOME DA RECEPCAO E DA UTILIDADE	19/09/2024

AUTOR (A) DO PROJETO EXECUTIVO
RENY MOITA PORTO
REGISTRO CAU: A163960-1BR

AUTOR (A) DO PROJETO EXECUTIVO
VIVIANE KELLI MACHADO
REGISTRO CAU: A38938 - 2

AUTOR (A) DO PROJETO EXECUTIVO
DANIELA MENEZES EMILIANO
REGISTRO CAU: A253522-0

AUTOR (A) DO PROJETO EXECUTIVO
BARBARA MOREIRA RIBEIRO
REGISTRO CREA: 7968

OBJETO
MATERNIDADE TIPO II

PROPRIETARIO
FUNDO ESTADUAL DE SAUDE - FES

ENDERECO
AV. TORQUATO TAPAJÓS, S/N, BAIRRO COLÔNIA TERRA NOVA, MANAUS-AM

TITULO DA PRANCHA
DETALHAMENTO BANCADAS EM PEDRA

DISCIPLINA
ARQUITETURA

PRANCHA
30/43

UNIDADE
METROS

DATA
03/09/2025

ESCALA
INDICADA

REGISTRO
CAU - 25669-2
CAU - 36015-5
CAU - 247155-6

REVISAO
R4

REVISAO R4 **UNIDADE** METROS **DATA** 03/09/2025 **ESCALA** INDICADA

NOME: PRANCHA-ARQUIVO **MS_MAT2_PE_AQ_30**

REVISAO: R4 **UNIDADE:** METROS **DATA:** 03/09/2025 **ESCALA:** INDICADA

AUTOR(A) INTELCTUAL: MIRELA PILON PESSATTI, SIMONE ALVES PRADO MENEZES, VICTORIA ANGELI CAPOVILLA

REGISTRO: CAU - 25669-2, CAU - 36015-5, CAU - 247155-6

DIREITOS AUTORAIS RESERVADOR CONFORME LEGISLAÇÃO NACIONAL E INTERNACIONAL

FOLHA Nº 04/10x59,40