

P1=P9=P13=P14=P16

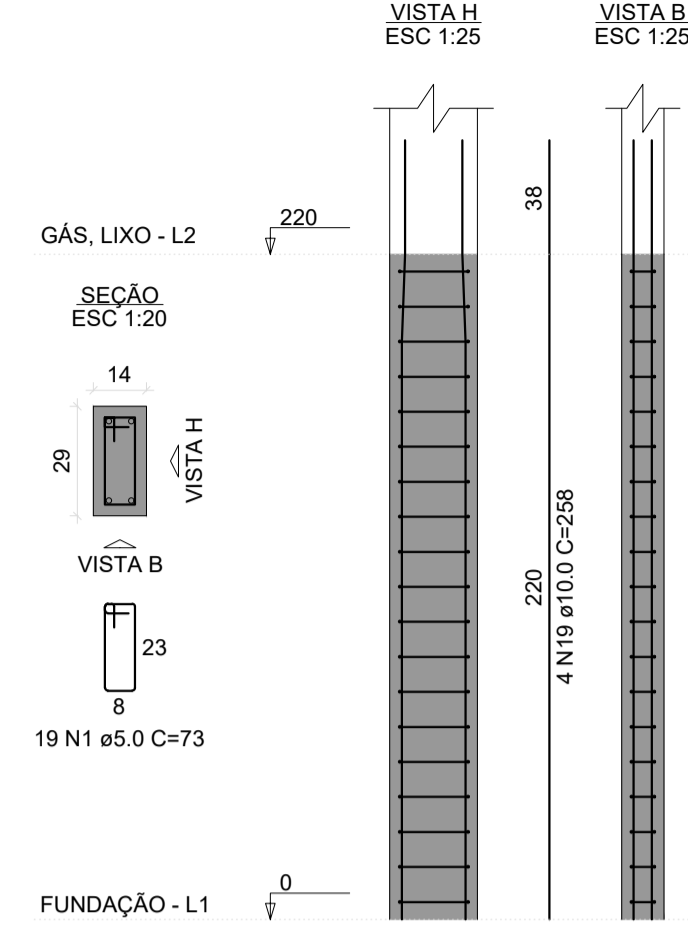

P2

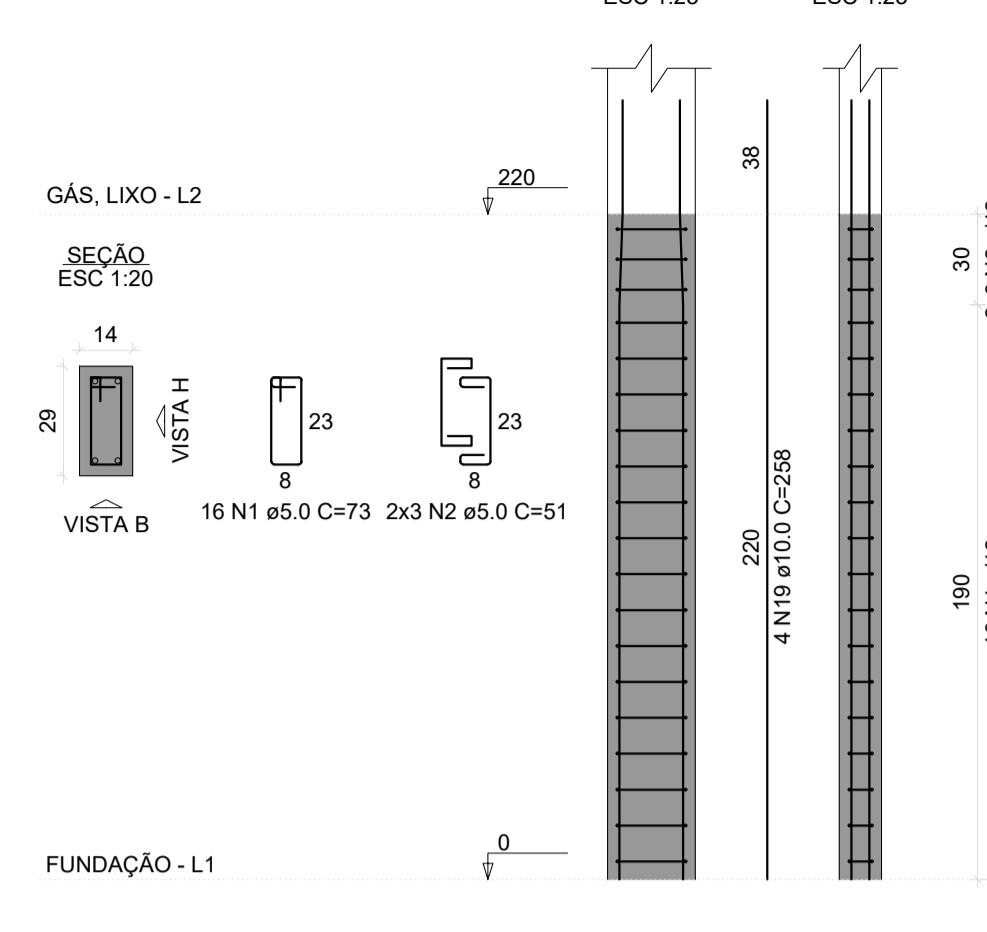

P3

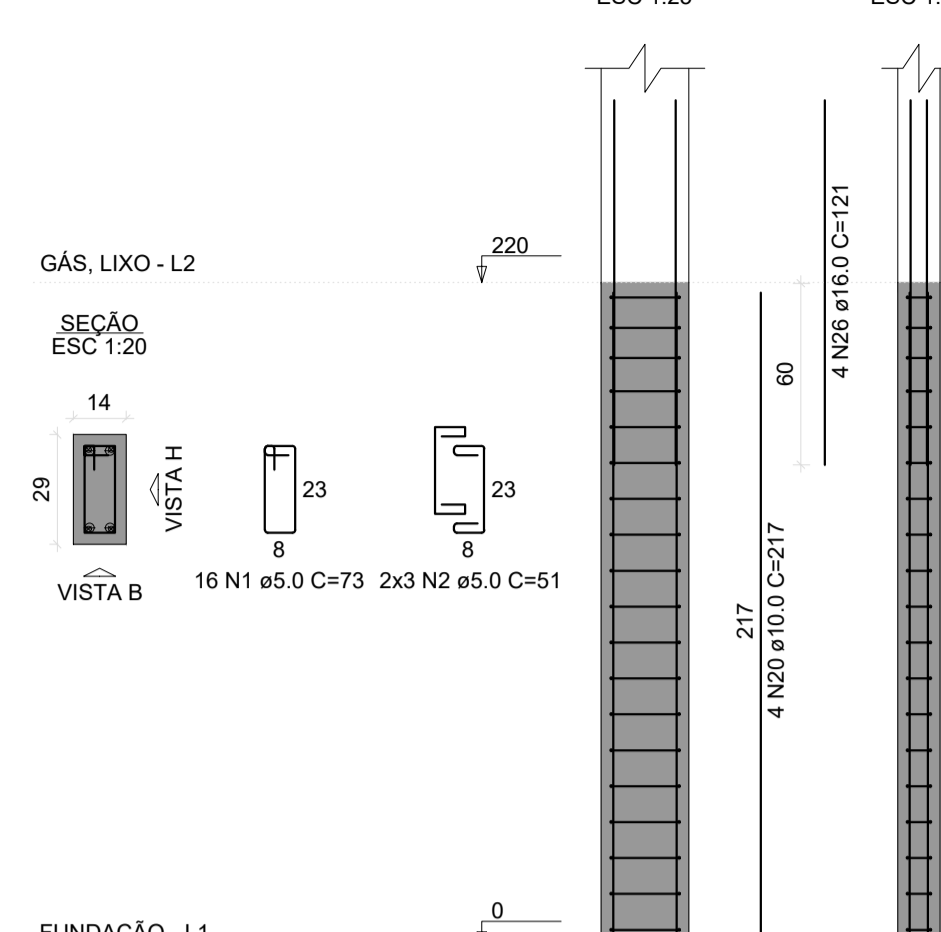

P4

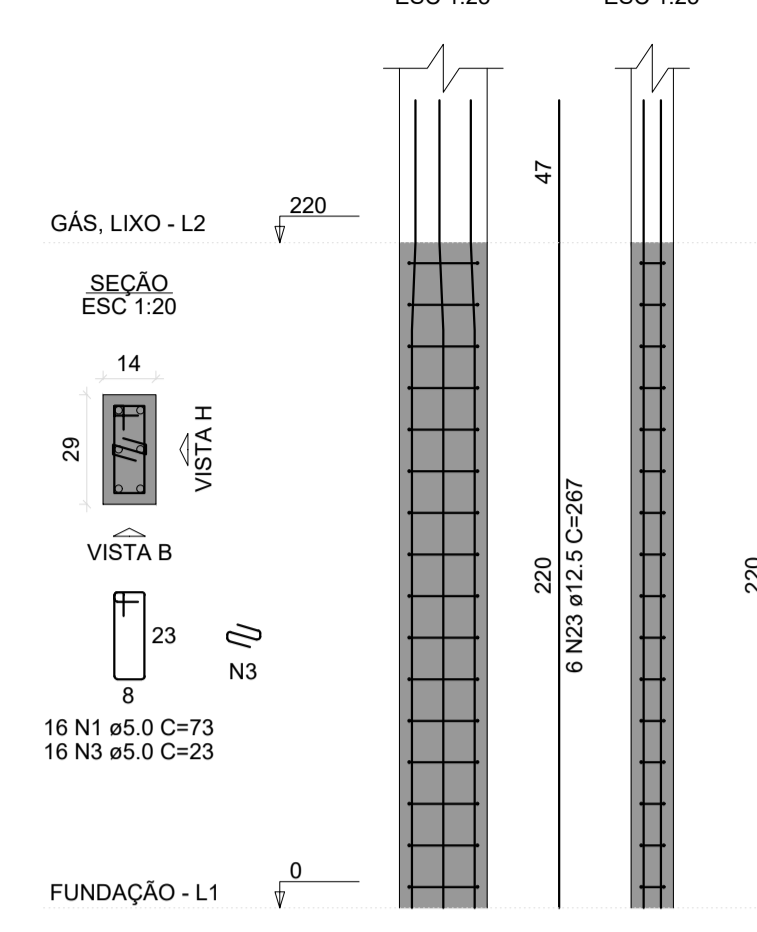

P5=P6=P7=P8

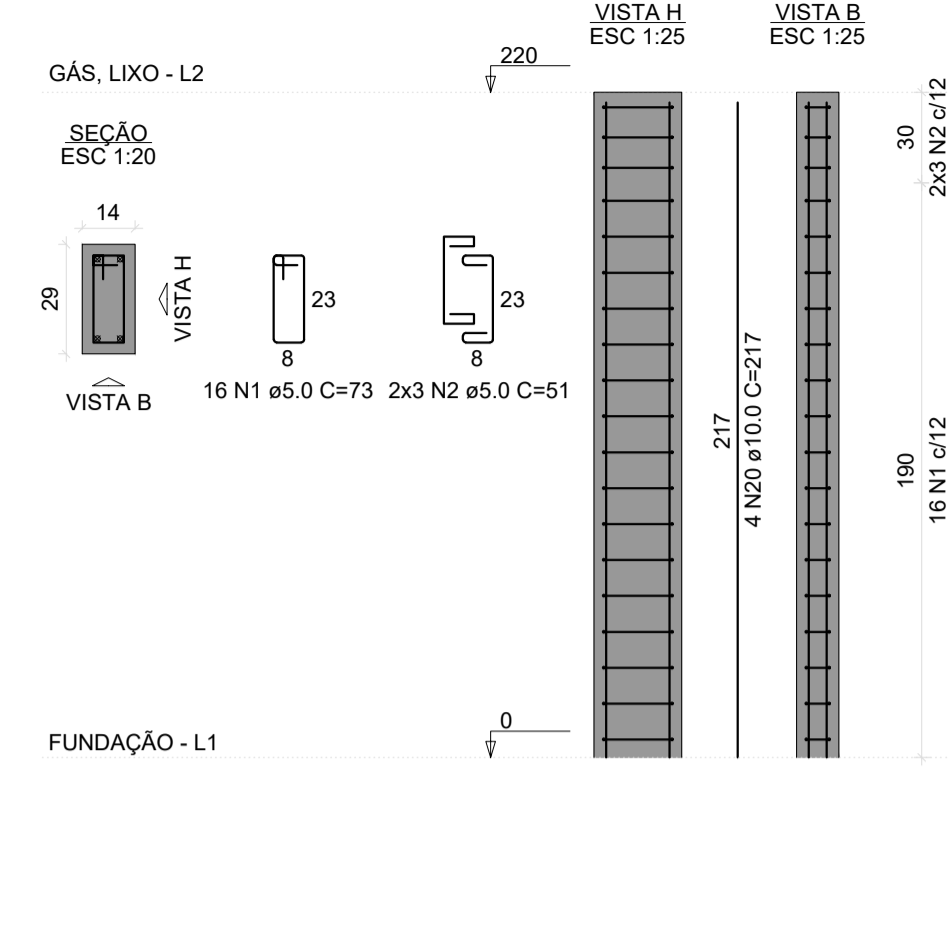

RELAÇÃO DO AÇO

AÇO	N	DIAM (mm)	QUANT	C.UNIT (cm)	C.TOTAL (cm)
CA60	1	5.0	324	73	23652
	2	5.0	114	51	5814
	3	5.0	47	23	1081
	4	5.0	8	23	184
	5	5.0	76	75	5700
CA50	6	8.0	2	253	506
	7	8.0	2	270	540
	8	8.0	2	238	476
	9	8.0	2	272	544
	10	8.0	2	161	322
	11	8.0	2	192	384
	12	8.0	2	176	352
	13	8.0	2	185	370
	14	8.0	6	123	738
	15	8.0	4	137	548
	16	8.0	2	131	262
	17	8.0	4	154	616
	18	10.0	30	77	2310
	19	10.0	32	263	8256
	20	10.0	20	217	4340
	21	10.0	6	75	450
	22	12.5	24	77	1848
	23	12.5	16	267	4272
	24	12.5	8	94	752
	25	16.0	4	77	308
	26	16.0	4	121	484

P10

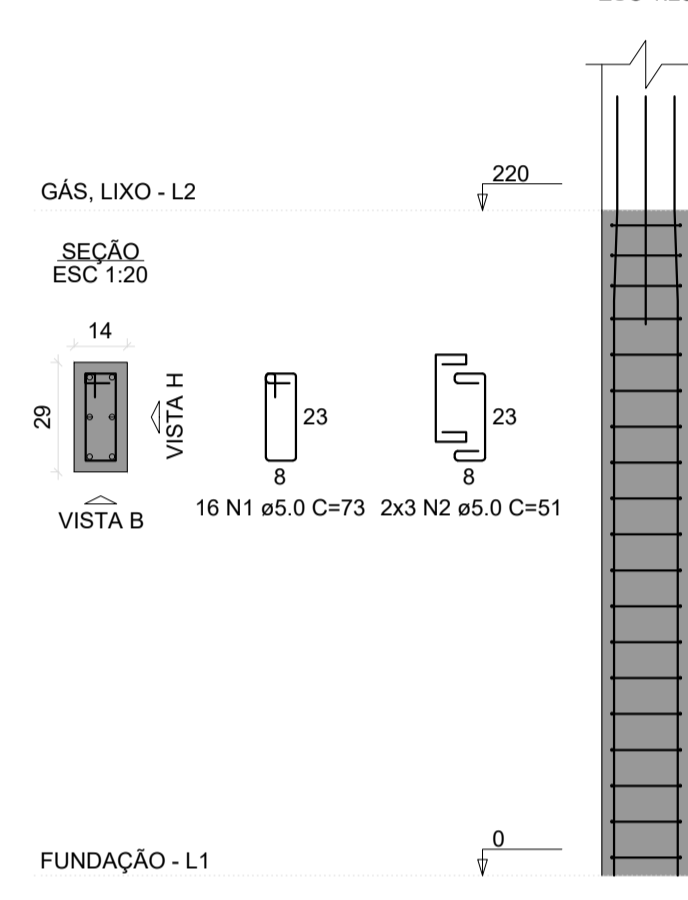

P11

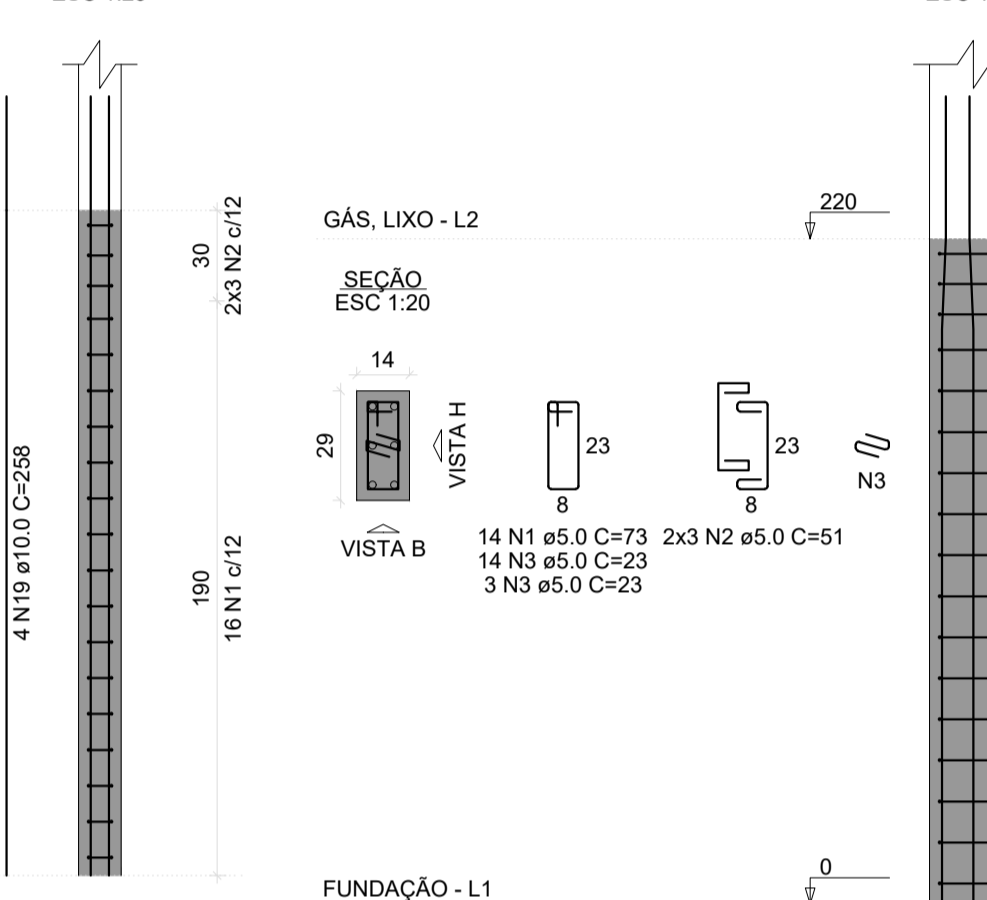

P12

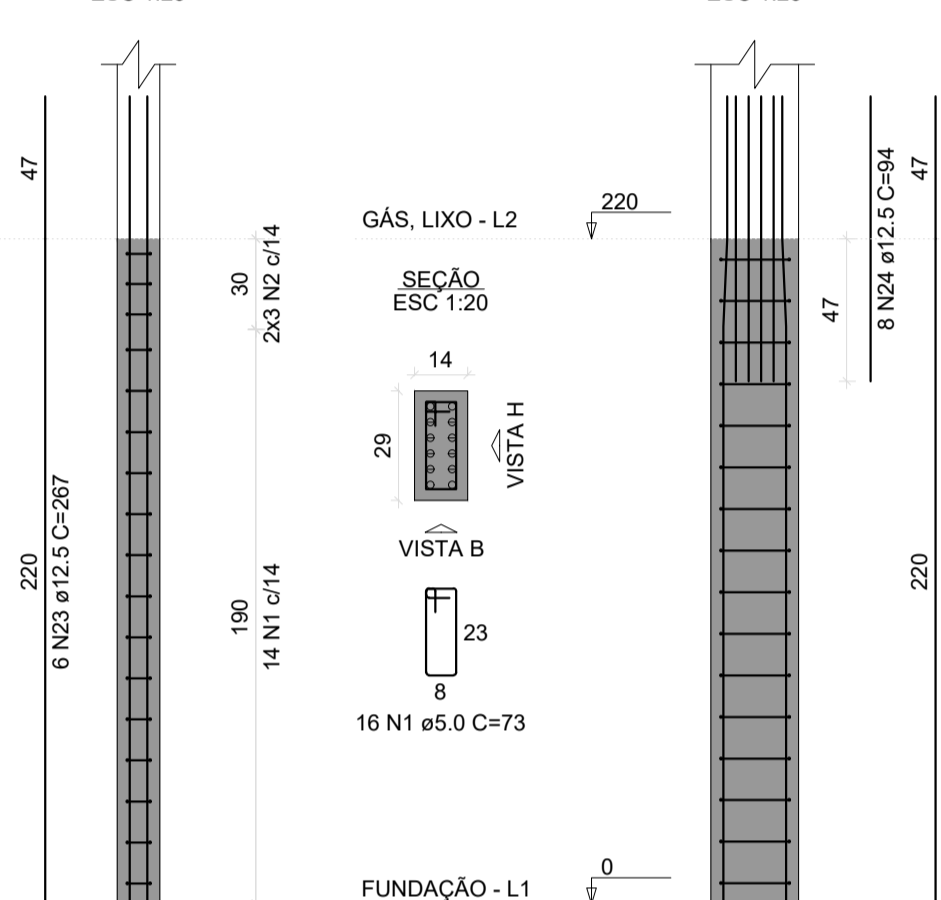

P15

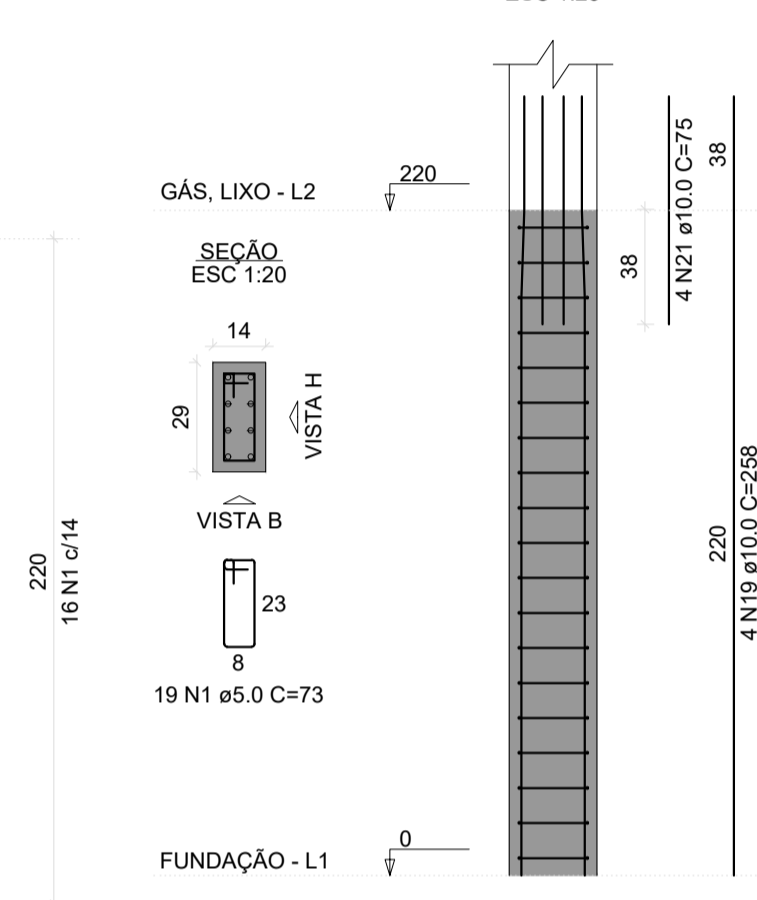

V1

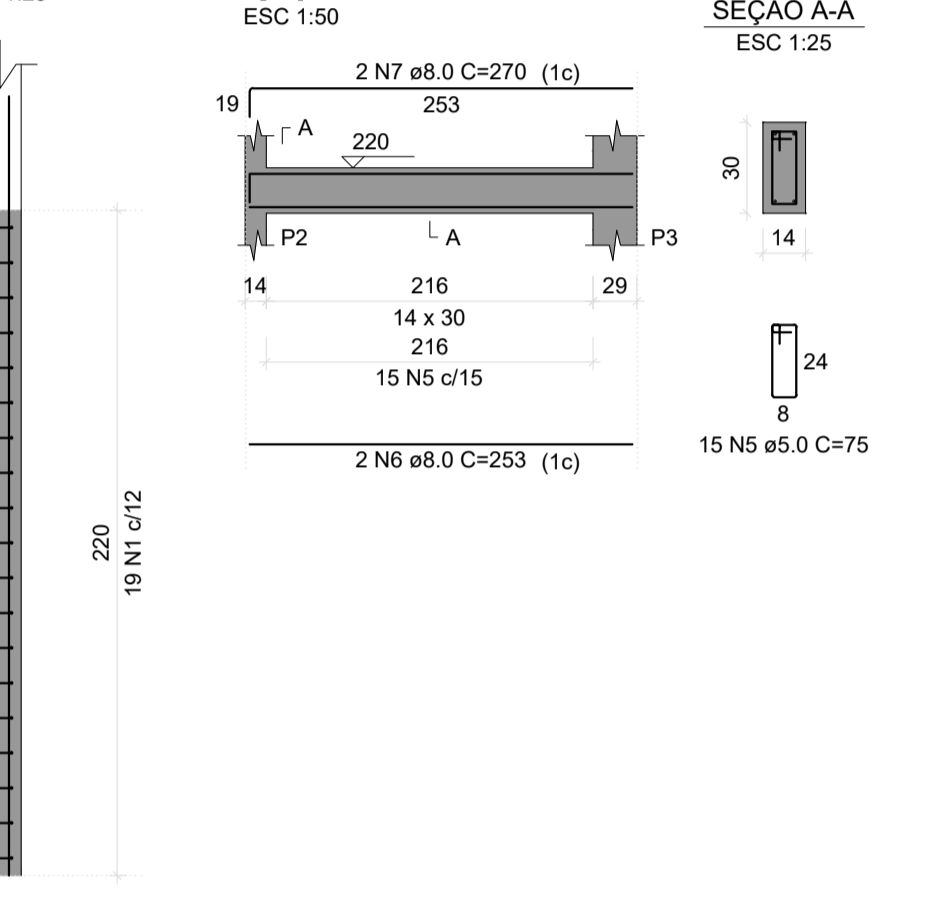

RESUMO DO AÇO

AÇO	DIAM (mm)	C.TOTAL (m)	PESO + 10% (kg)
CA50	8.0	56.6	24.6
	10.0	153.6	104.1
	12.5	88.7	72.8
	16.0	7.9	13.8
CA60	5.0	364.3	61.8

PESO TOTAL (kg)
CA50 215.3
CA60 61.8

Volume de concreto (C-25) = 2.36 m³
Área de forma = 43.89 m²

V2

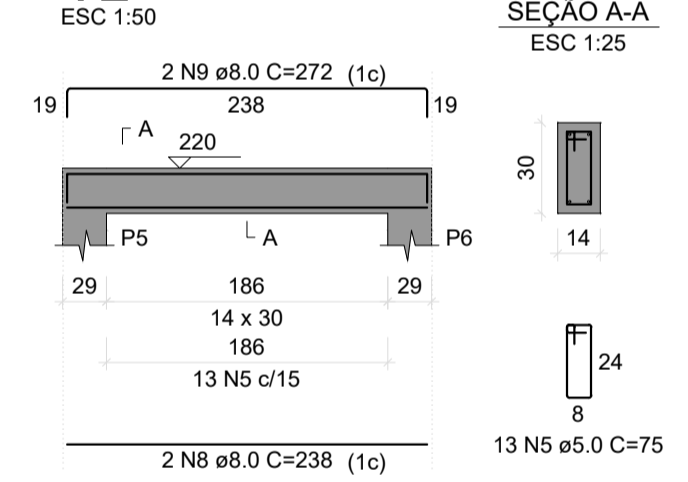

V3

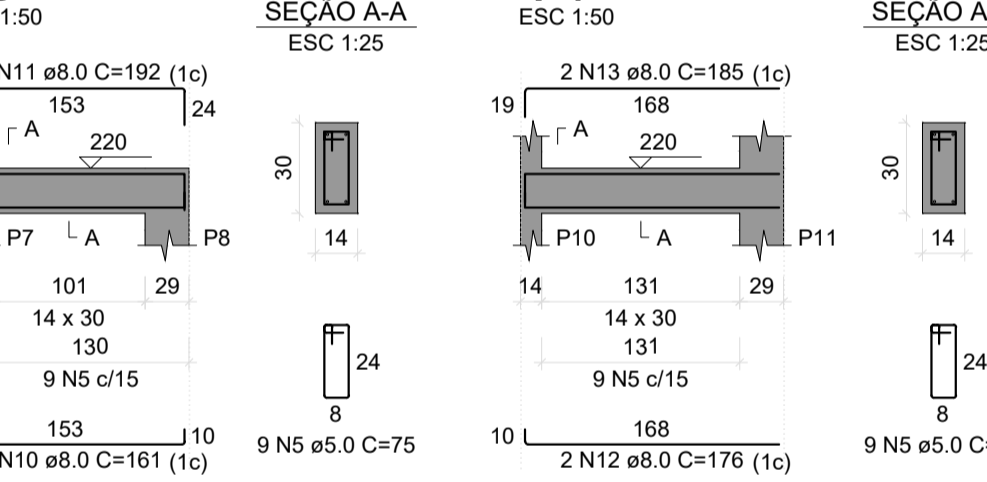

V4

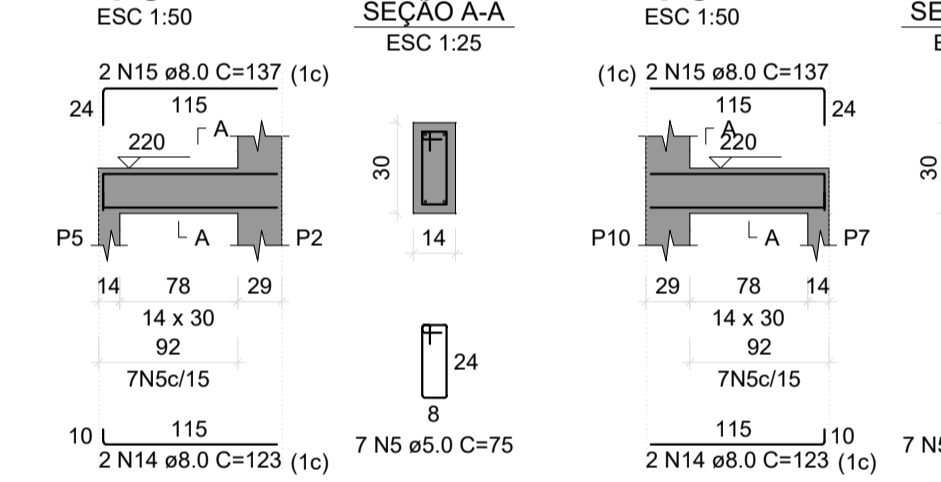

V5

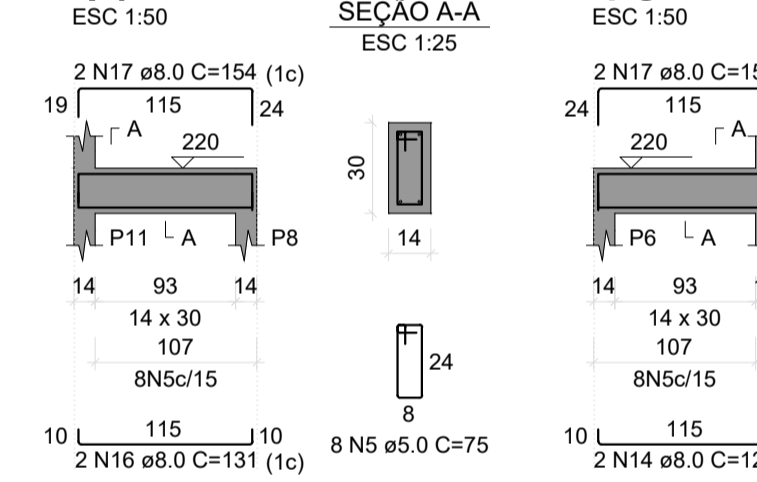

V6

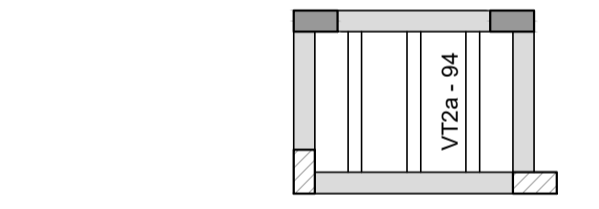
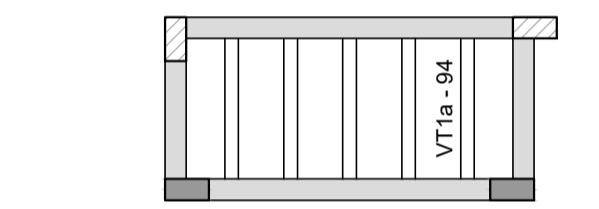

PLANTA DE VIGOTAS PRÉ-MOLDADAS

Escala 1:50

P1=P2=P9=P13=P14=P16

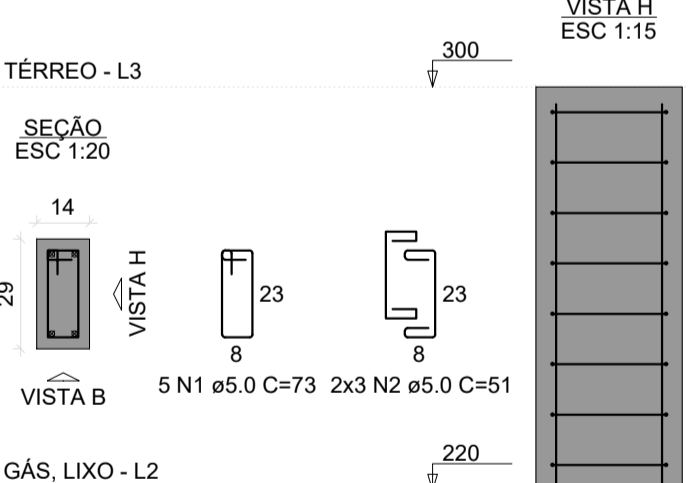

P3

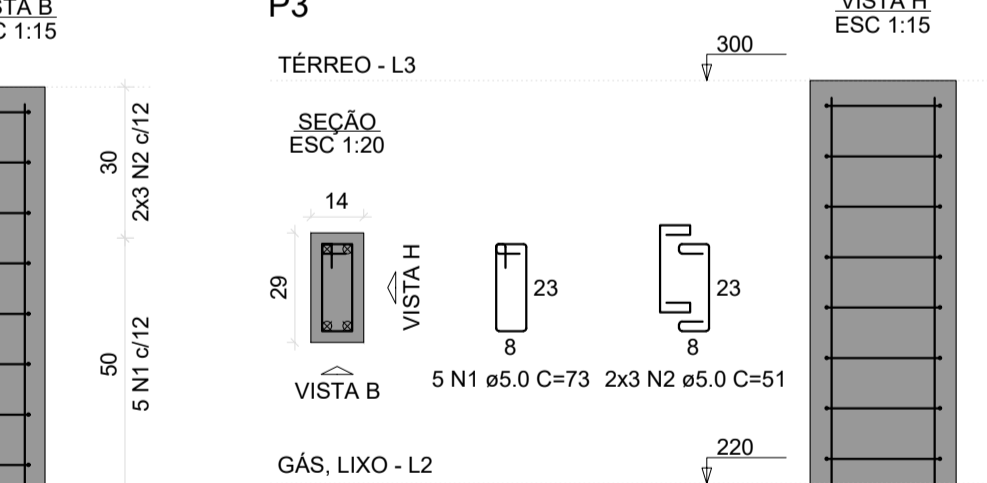

P4=P11

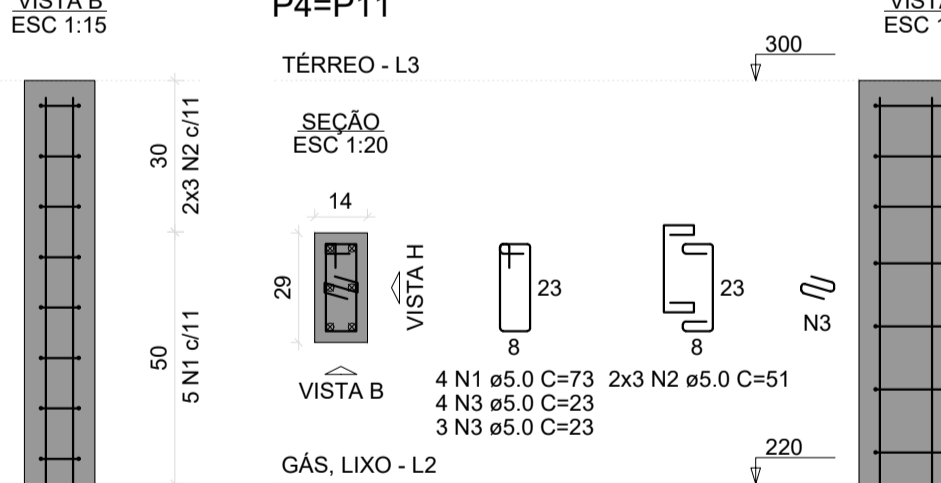

P10

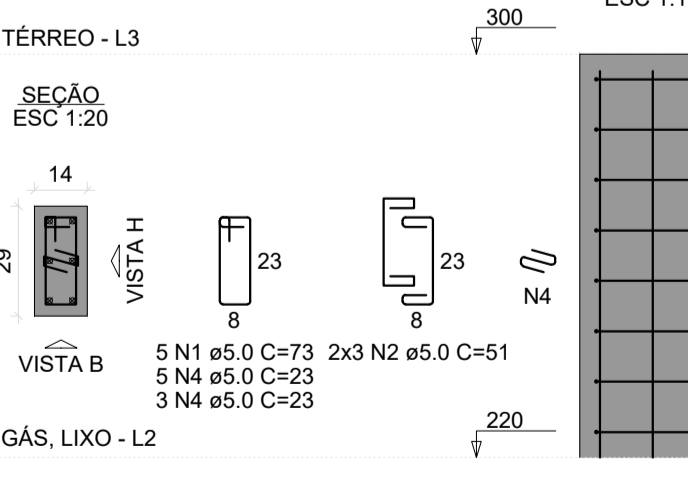

P12

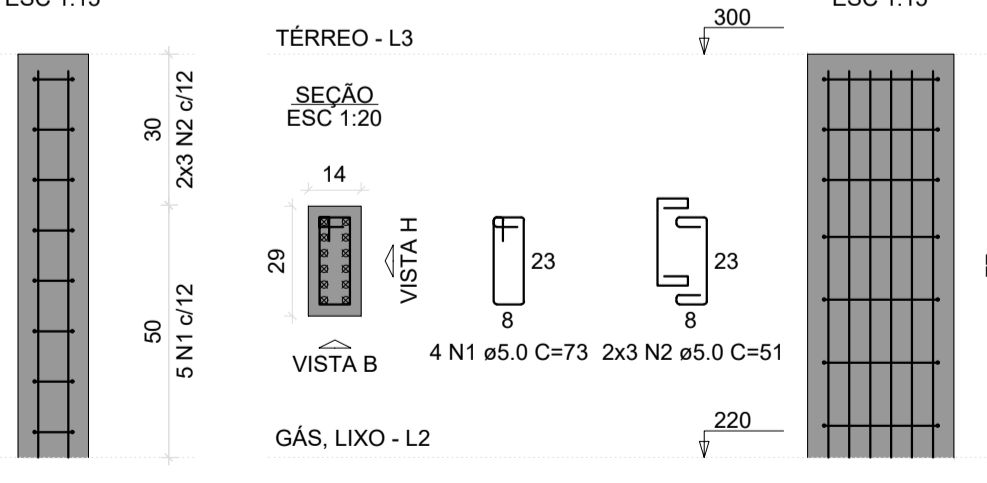

ARMAÇÃO POSITIVA (EIXO Y)

Escala 1:50

PREFEITURA MUNICIPAL DE SEBASTIÃO LARANJEIRAS

PREFEITURA MUNICIPAL DE SEBASTIÃO LARANJEIRAS

GESTÃO -

PROJETO ESTRUTURAL

CONSTRUÇÃO DE COZINHA

ENGENHEIRO: HENRIQUE RODRIGUES	CREA. 141978497-8	ASSINATURA
DATA 03/2026	PRANCHA	HENRIQUE RODRIGUES 141978497-8
ESCALA INDICADAS	CONTEÚDO DA PRANCHA	
		02/04