

# PLANTA BAIXA ARQUIBANCADA

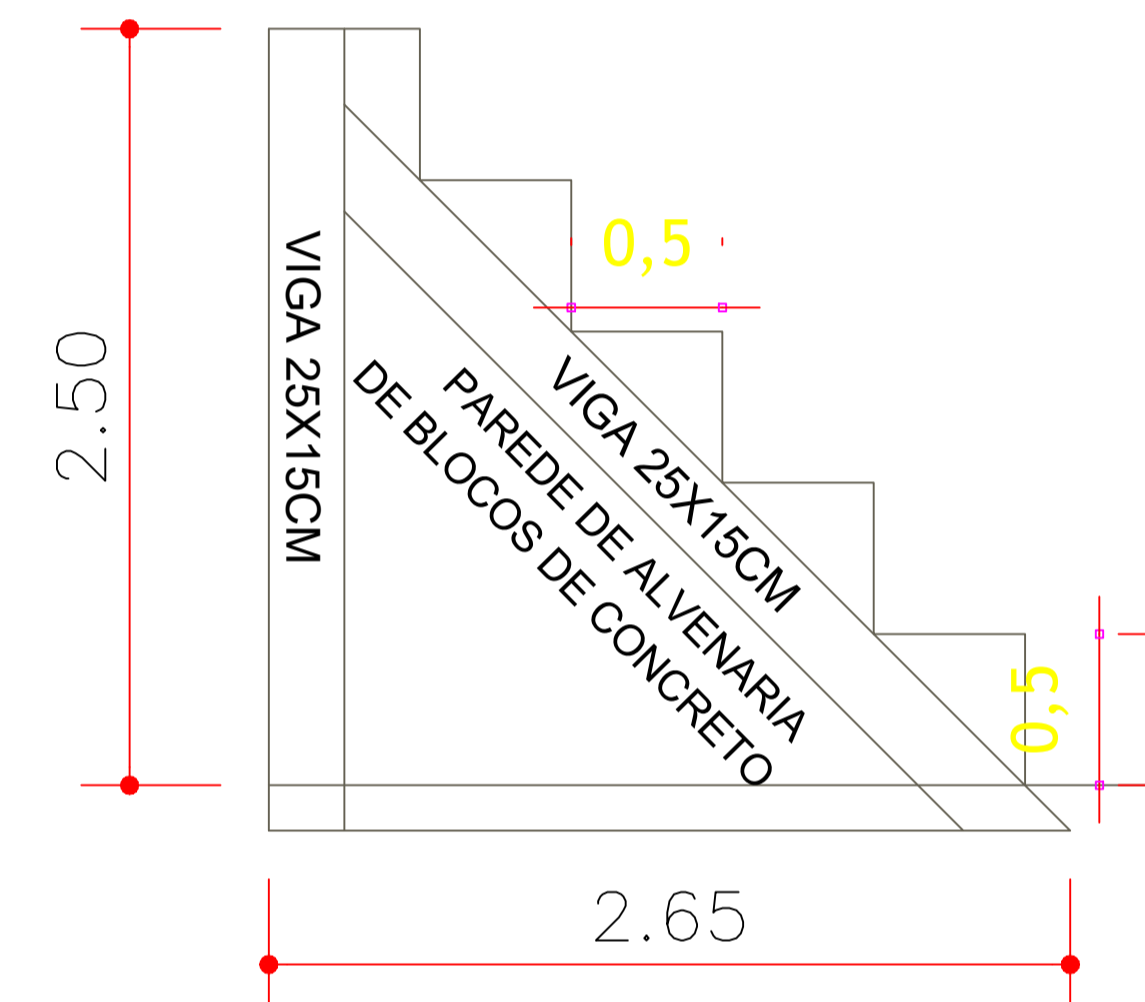

## VB - 1 (15 x 30)

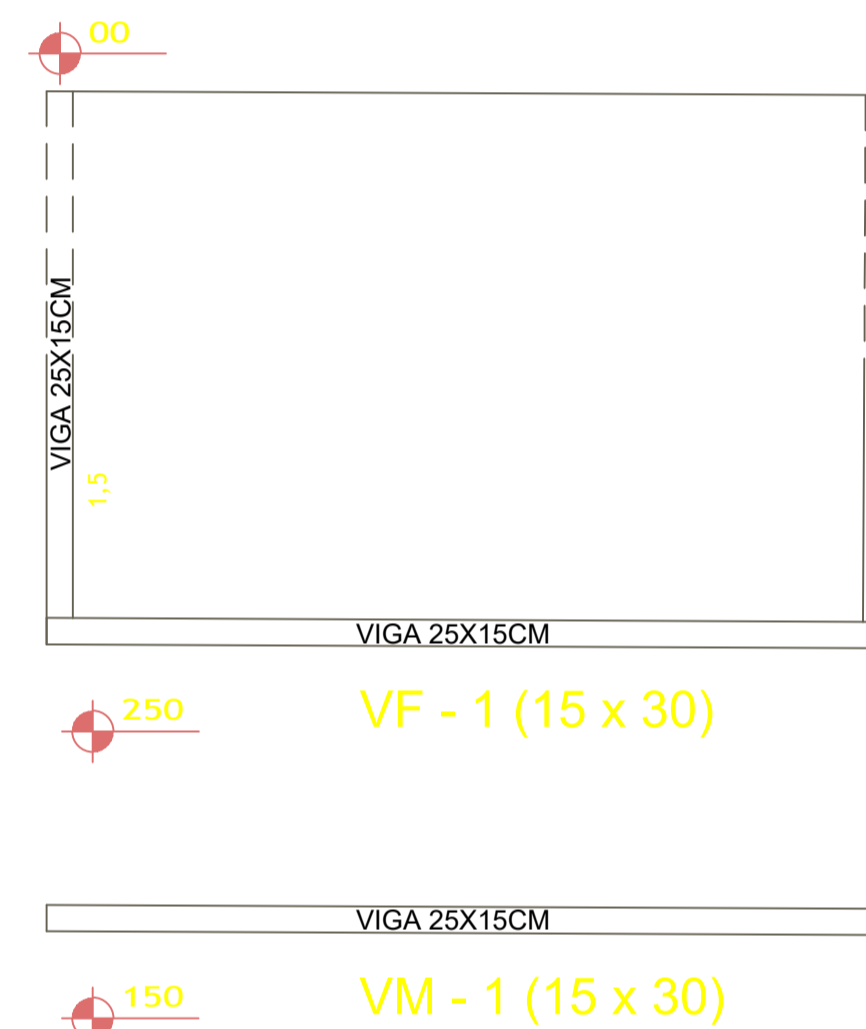
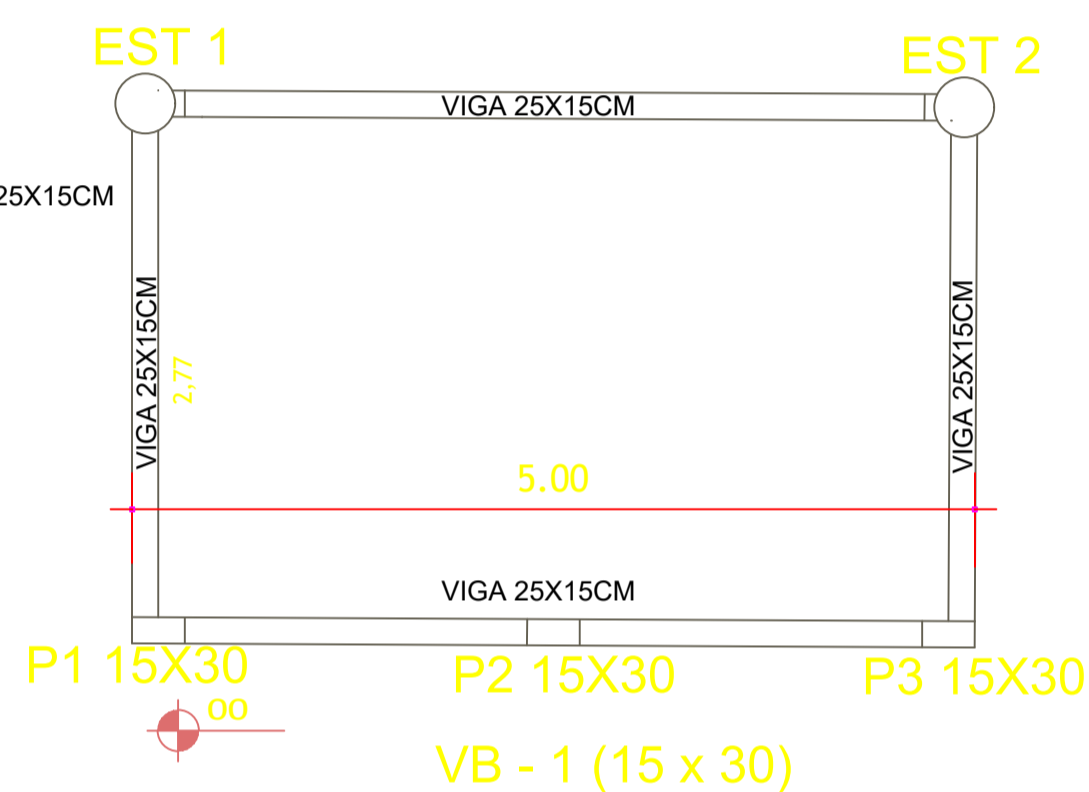
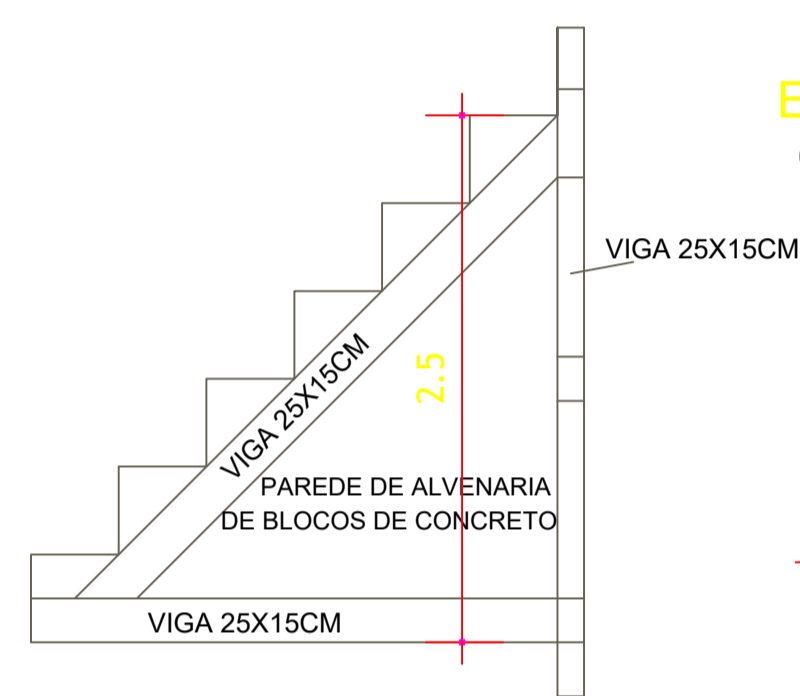
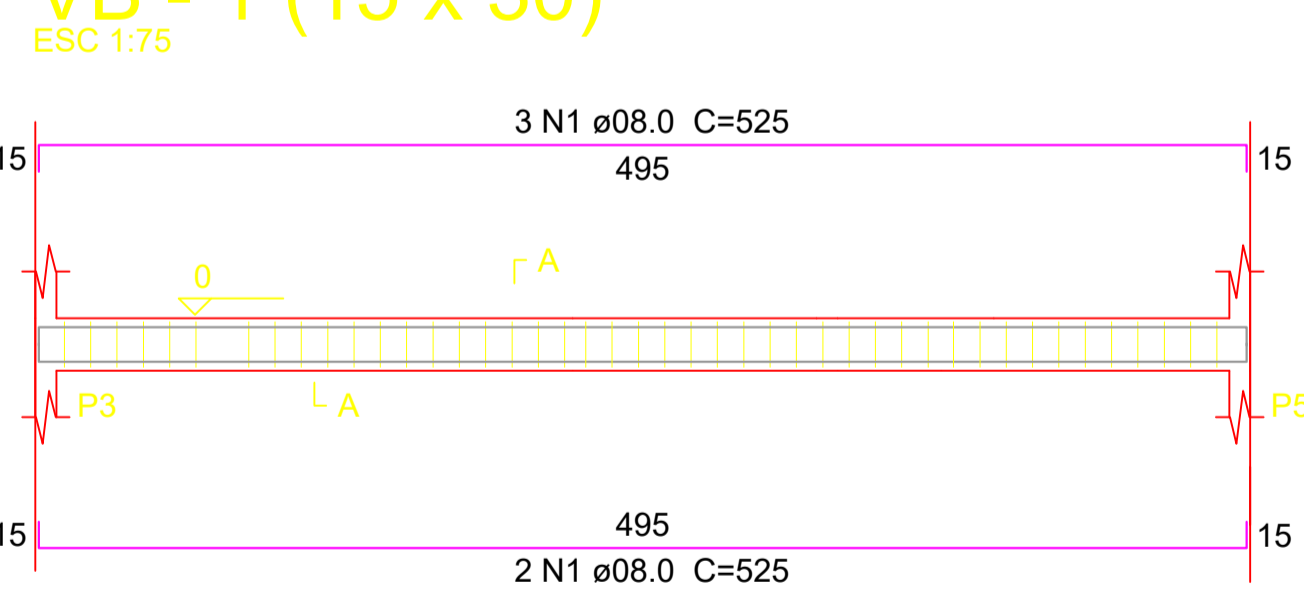

## VL - 1 (15 x 30)

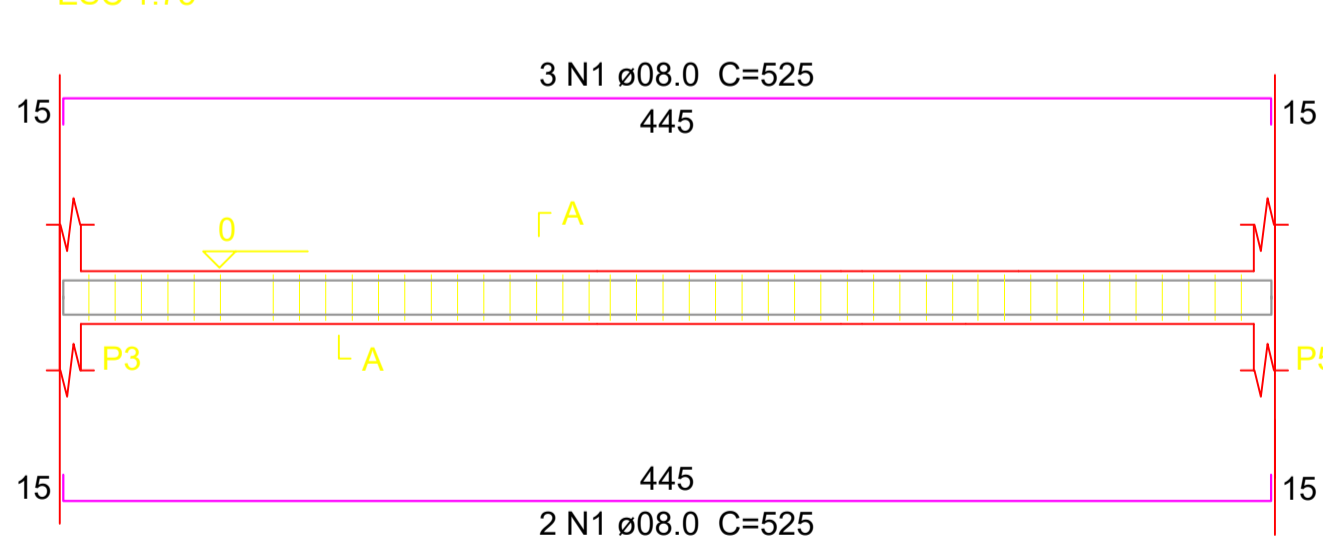

## VB - 2 (15 x 30)

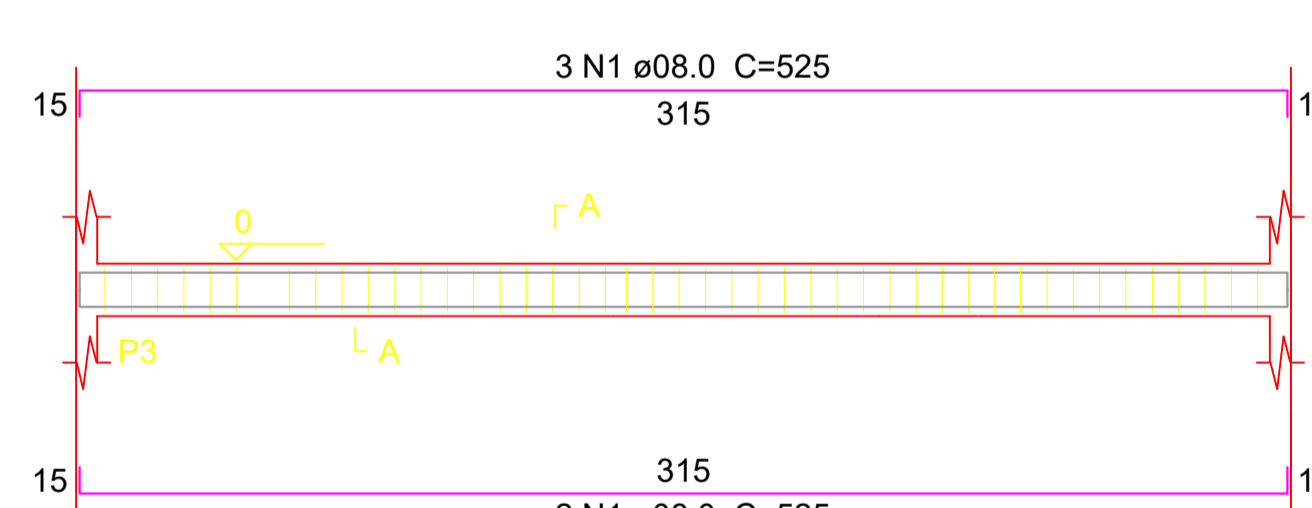

## VM - 1 (15 x 30)

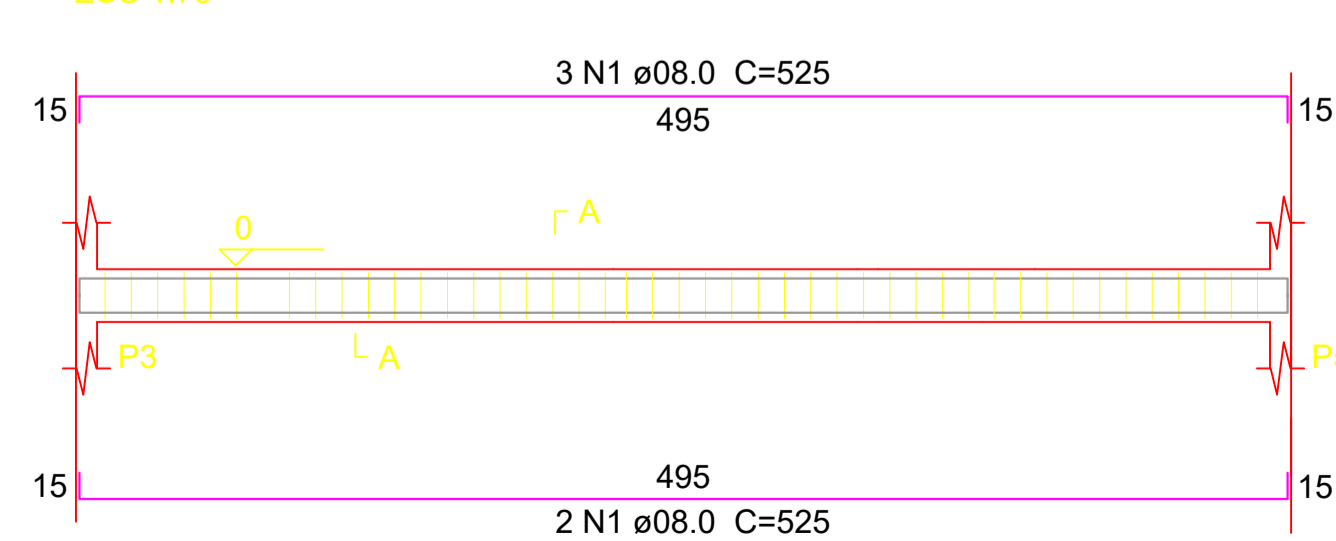

## VF - 1 (15 x 30)

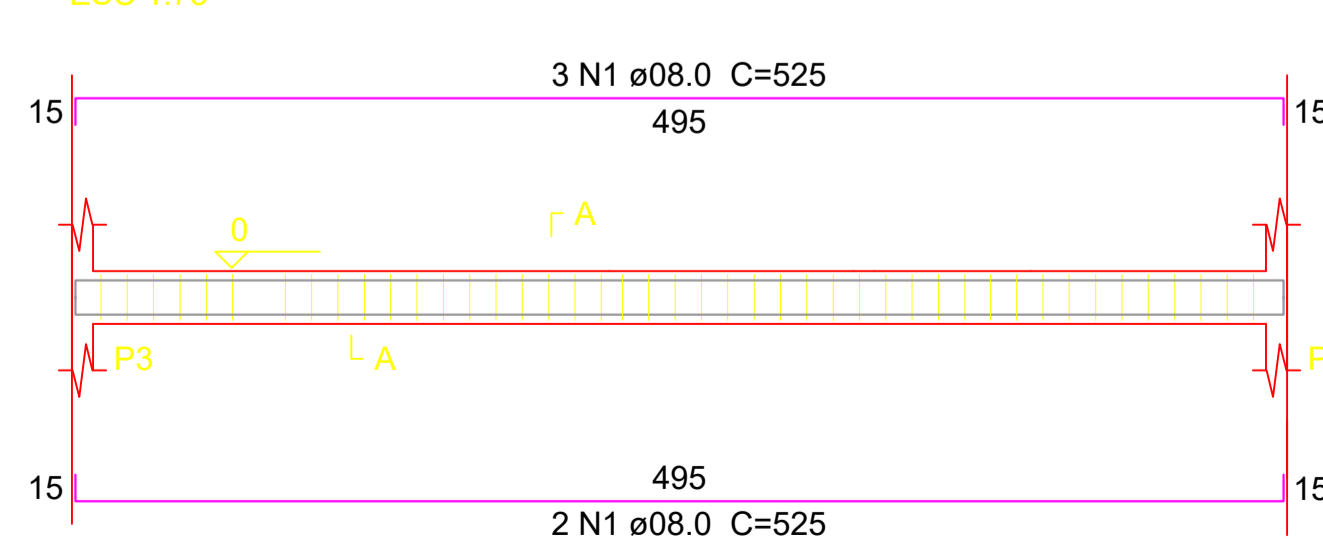

## VB - 3 (15 x 30)

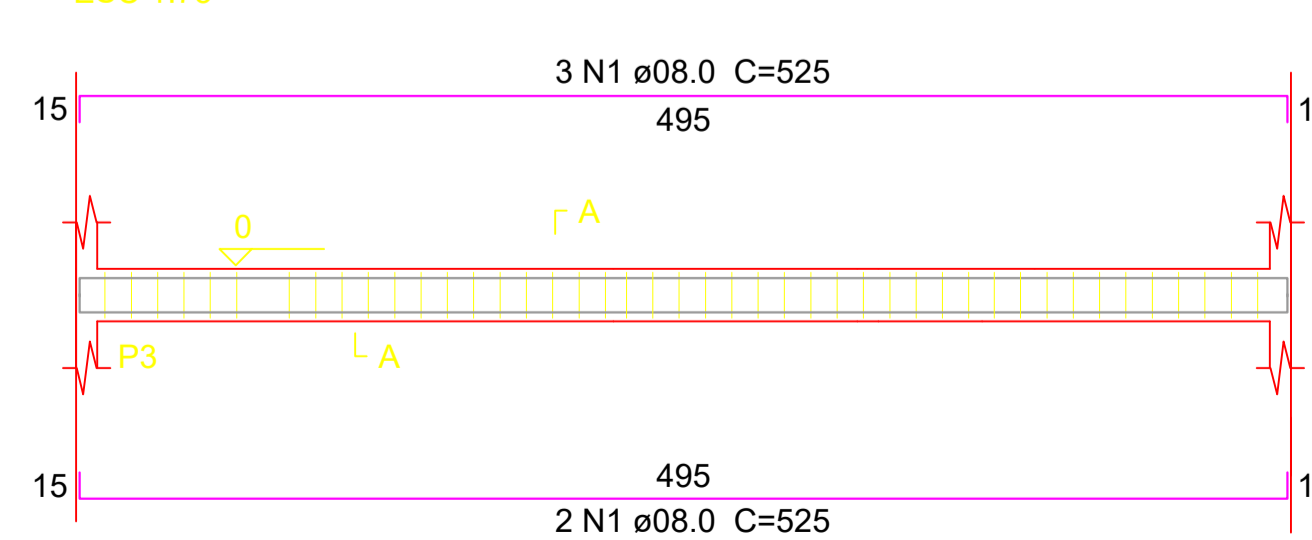

**NOTAS**

- COTAS EM CENTIMETROS
- COTAS DE NÍVEL EM METROS
- CONFERIR MEDIDAS, ABERTURAS, NÍVEIS E PRUMOS NO LOCAL
- MEDIDAS EM COTAS PREVALECEM SOBRE O DESENHO
- ESSE DESENHO DEVE SER IMPRESSO COLORIDO

DATA	DESENHO	RESPONSÁVEL	FOLHA
Jun/2026	ELISMAR M	ENG. ELISMAR M. LOURENO	01/01

ESCALA	ARQUIVO	FASE
INDICADA	ARQBASE TEMPLATE(M)(PT)_V2.2.DWG	EXECUTIVO

**TÍTULO**  
 PLANTA BAIXA ARQUIBANCADA  
 CORTES  
 ESTRUTURAL

**PROJETO**  
 RESIDENCIAL

**CLIENTE**  
 MUNICÍPIO DE PALESTINA DE GOIÁS

**TRABALHO DESENVOLVIDO POR**

