

01 CORTE AA  
ESCALA: 1:50

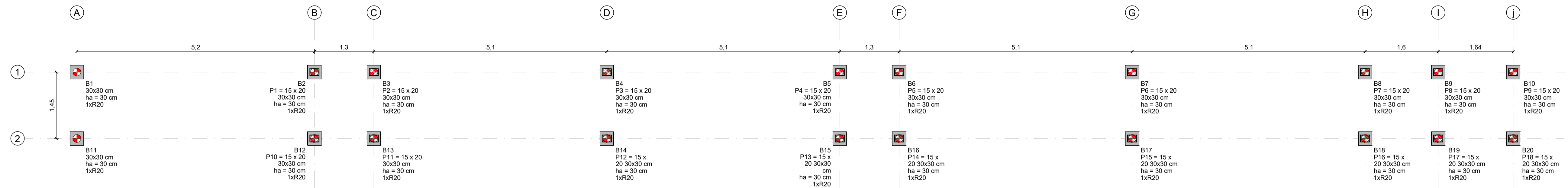

02 LOCAÇÃO PILARES/VIGAS 0,00 m  
ESCALA: 1:50

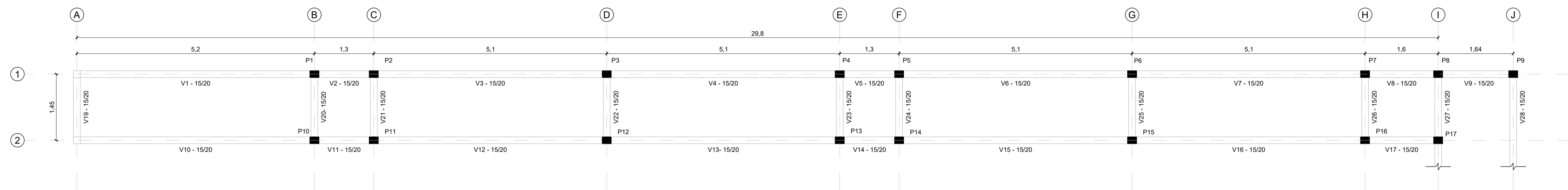

03 LOCAÇÃO - BALDRAMES 0,00 m  
ESCALA: 1:50

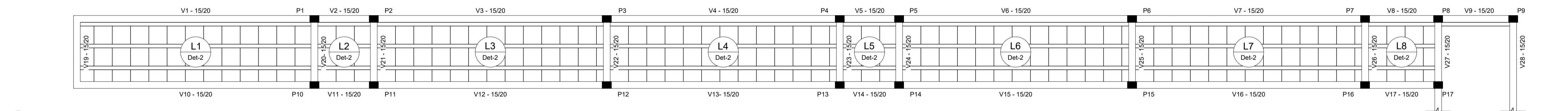

04 FORMA - LAJE DE PISO/RAMPA  
ESCALA: 1:50

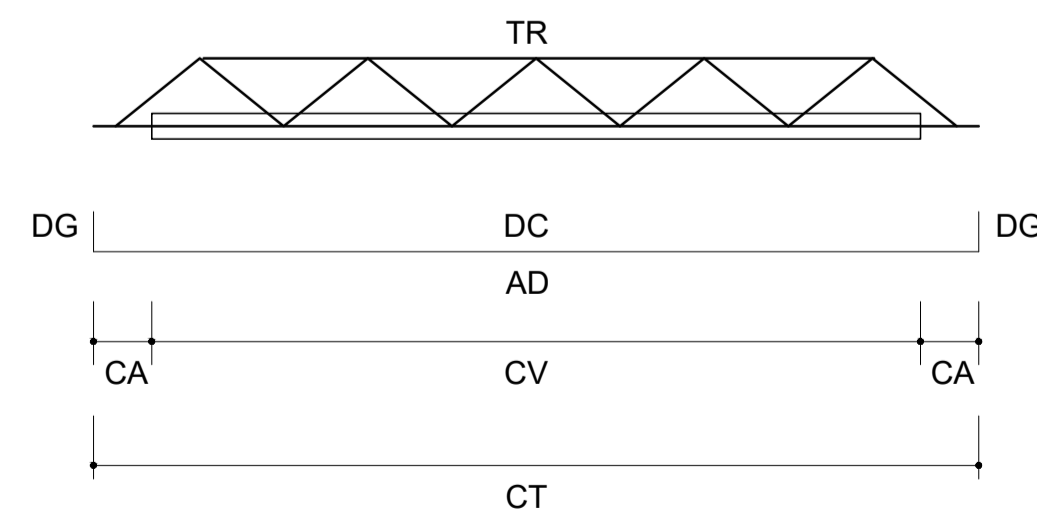
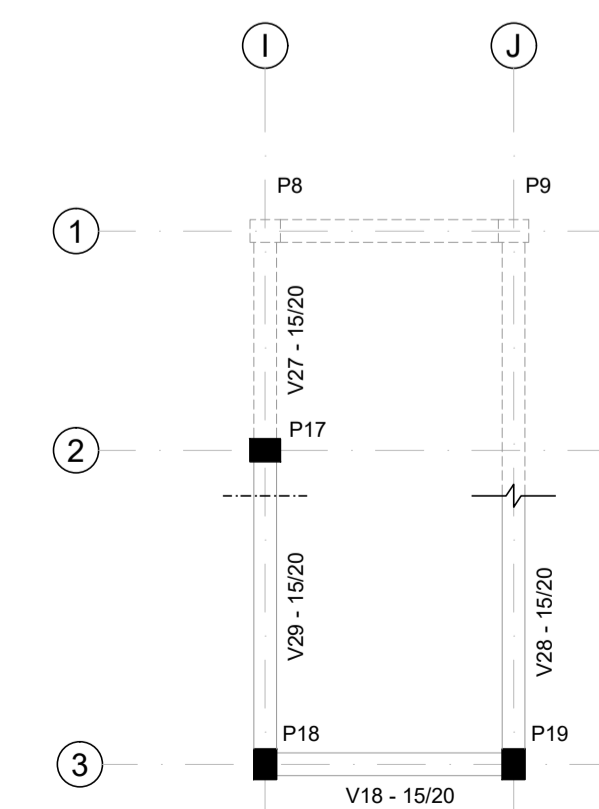

**LEGENDA**  
 CV: comprimento da vigota  
 CA: comprimento adicional da treliça TR: tipo de treliça  
 AD: armadura adicional  
 DC: comprimento da armadura adicional DG: gancho da armadura adicional

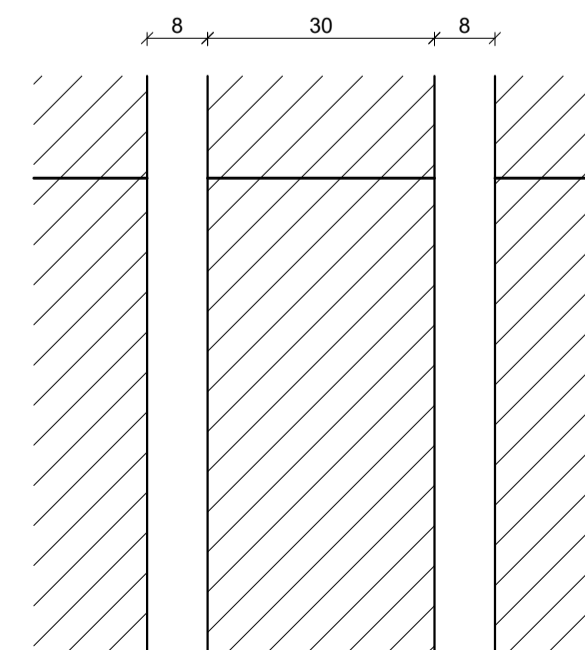

**BLOCOS DE ENCHIMENTO**

DETALHE	TIPO	NOME	DIMENSÕES (cm)			QUANTIDADE
			hb	bx	by	
1	EPS UNIDIRECIONAL	B8/30/125	8	40	40	38

05 LOCAÇÃO PILARES 1,70 m  
ESCALA: 1:50

06 DET. 01

07 DET. 02  
ESCALA: 1:10

ID Nº 1117659 ESCOLA 2 SALAS

ENDEREÇO: PARECI NOVO, RS, EMEF CATHARINA F. WEISSHEIMER  
 MUNICÍPIO - UF: PARECI NOVO, RS  
 PREFEITURA MUNICIPAL DE PARECI NOVO, RS  
 PROPRIETÁRIO:  
 RESP. TÉCNICO: CREA/CAU

OBSERVAÇÕES: ART

**PROJETO DE ESTRUTURA**

PROJETO ESTRUTURAL  
RAMPA

EST.

FORMATO	A1 (840X594)	REVISÃO	R.00	ESCALA	INDICADA	PRANCHA	01/03
		R.00		DATA EMISSÃO	24/10/2025		
		R.00					

P1 a P18

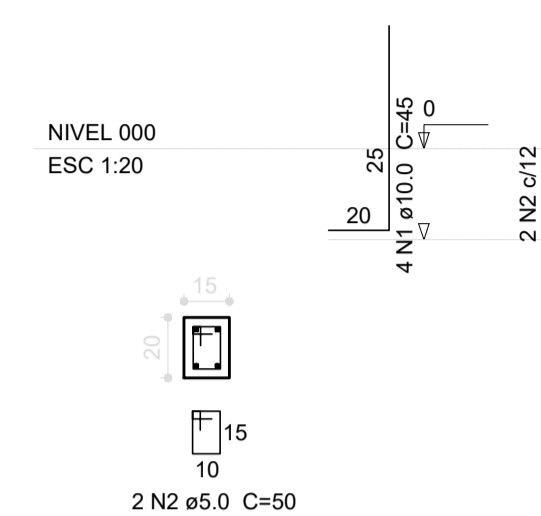

B1 A B20

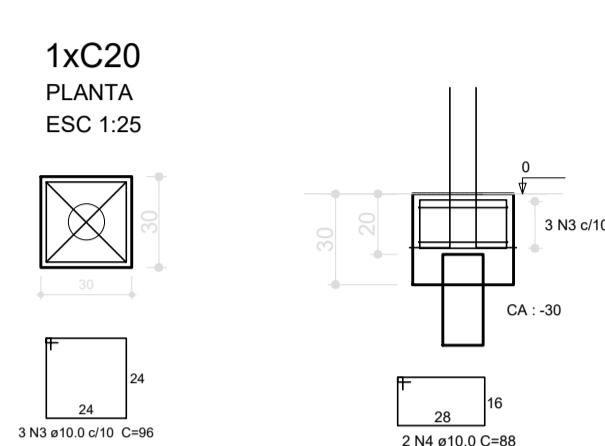

CORTE ESC 1:25

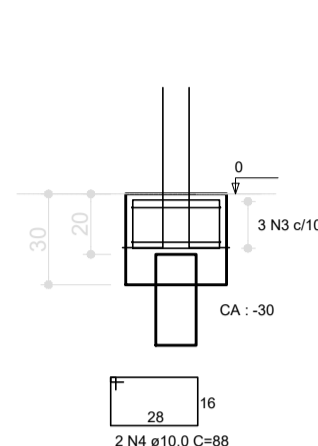

DETALHAMENTO DA ESTACA

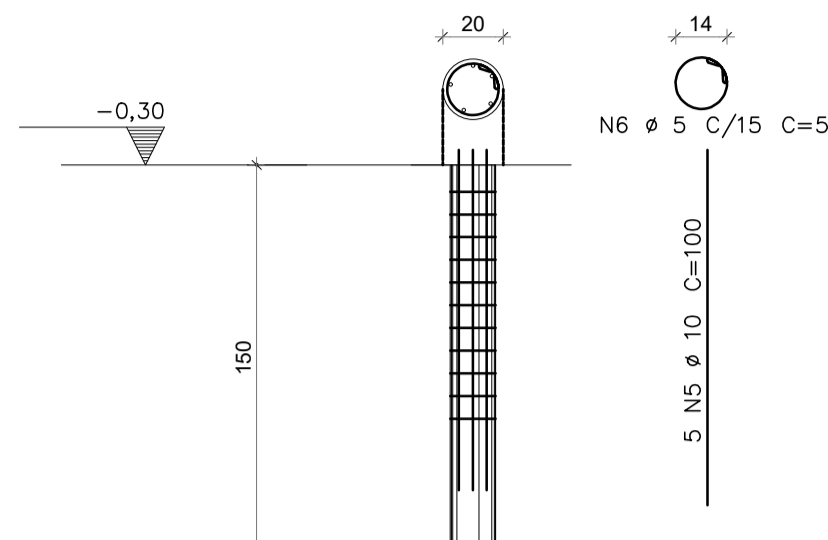

Relação do aço

AÇO	N	DIAM (mm)	QUANT (Barras)	UNIT (cm)	C.TOTAL (cm)
CA60	2	5.0	36	50	1800
CA50	1	10.0	72	45	3240
	3	10.0	54	96	5760
	4	10.0	40	88	3520

Resumo do aço

AÇO	DIAM (mm)	C.TOTAL (m)	PESO (kg)
CA50	10.0	125.2	77.2
CA60	5.0	18	2.8
PESO TOTAL (kg)			
CA50	77.2		
CA60	2.8		

Volume de concreto (C-25) = 0.54m³  
Área de forma = 7.20 m²

01 DETALHAMENTO BLOCOS E ESTACAS

ESCALA: INDICADA

P1=P2=P10=P11

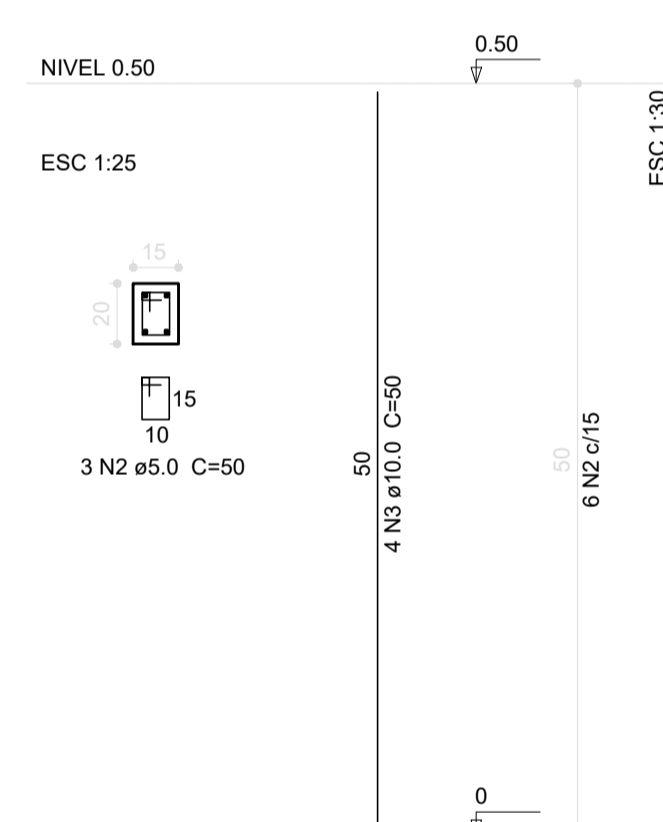

P3=P12

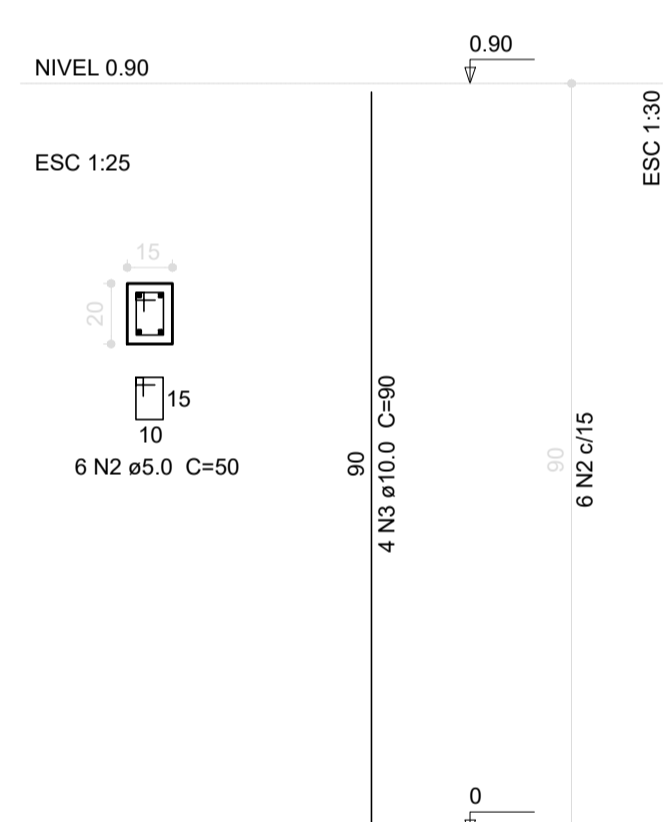

P4=P5=P13=P14

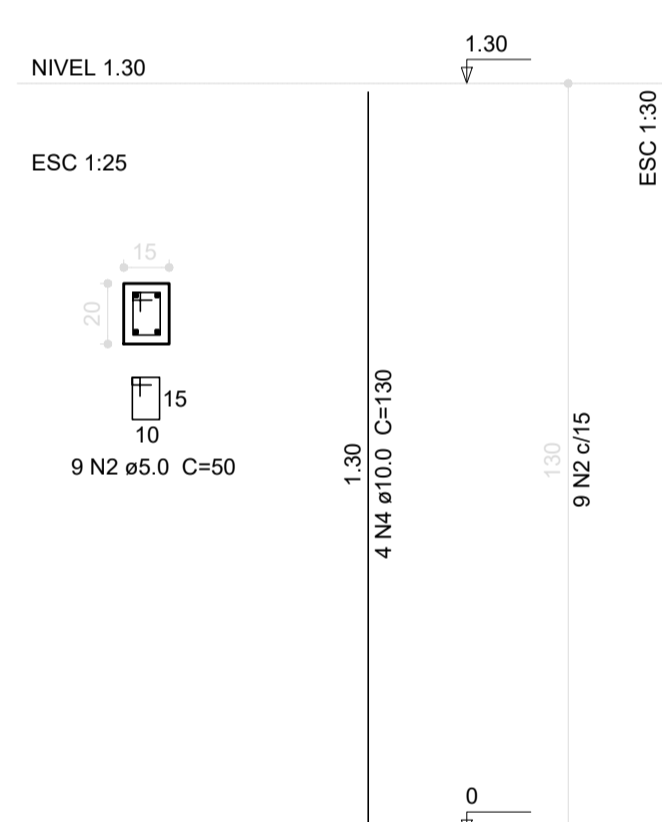

P6=P15

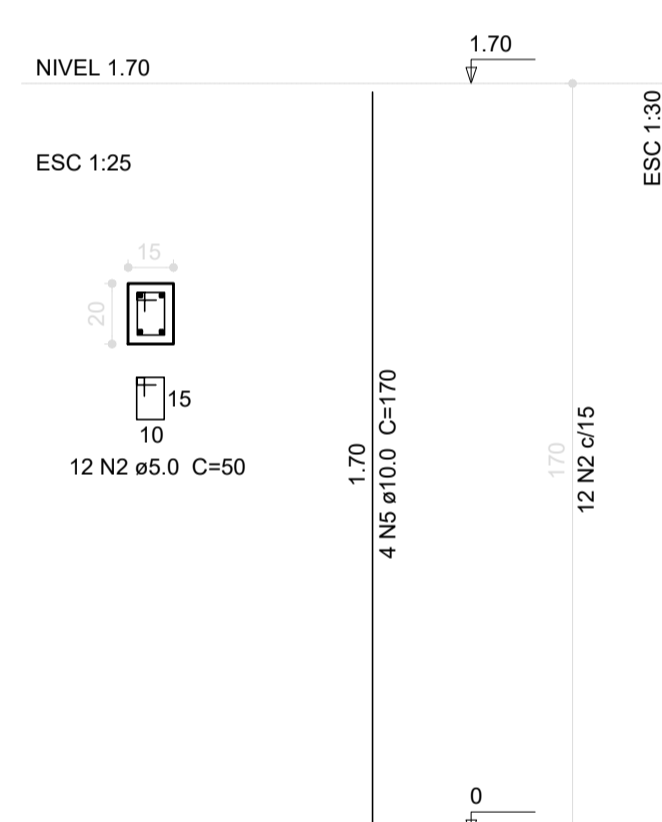

Relação do aço

AÇO	N	DIAM (mm)	QUANT (Barras)	UNIT (cm)	C.TOTAL (cm)
CA60	2	5.0	168	50	8400
CA50	1	10.0	16	50	800
	3	10.0	8	90	720
	4	10.0	16	130	2080
	5	10.0	8	170	1360
	6	10.0	24	210	5040

Resumo do aço

AÇO	DIAM (mm)	C.TOTAL (m)	PESO (kg)
CA50	10.0	100	61.7
CA60	5.0	84	13.0
PESO TOTAL (kg)			
CA50	61.7		
CA60	13.0		

Volume de concreto (C-25) = 0.80 m³  
Área de forma = 17.50 m²

P7=P8=P9=P16=P17=P18

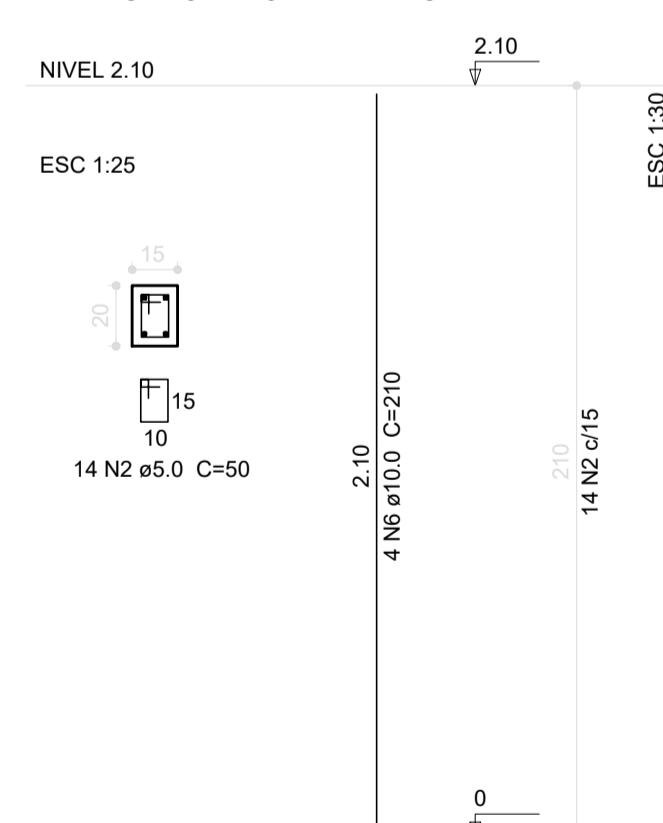

02 DETALHAMENTO DOS PILARES

ESCALA: INDICADA

ID Nº 1117659 ESCOLA 2 SALAS

ENDEREÇO: PARECI NOVO, RS, EMEF CATHARINA F. WEISSHEIMER

MUNICÍPIO - UF: PARECI NOVO, RS

PREFEITURA MUNICIPAL DE PARECI NOVO, RS

PROPRIETÁRIO

RESP. TÉCNICO

CREA/CAU

OBSERVAÇÕES:

ART

PROJETO DE ESTRUTURA

PROJETO ESTRUTURAL  
RAMPA

EST.

FORMATO A1 (840X594)

REVISÃO R.00 R.00 R.00

ESCALA INDICADA  
DATA EMISSÃO 24/10/2025

PRANCHA

02/03

V1=V10  
ESC 1:50

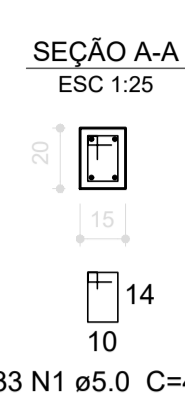
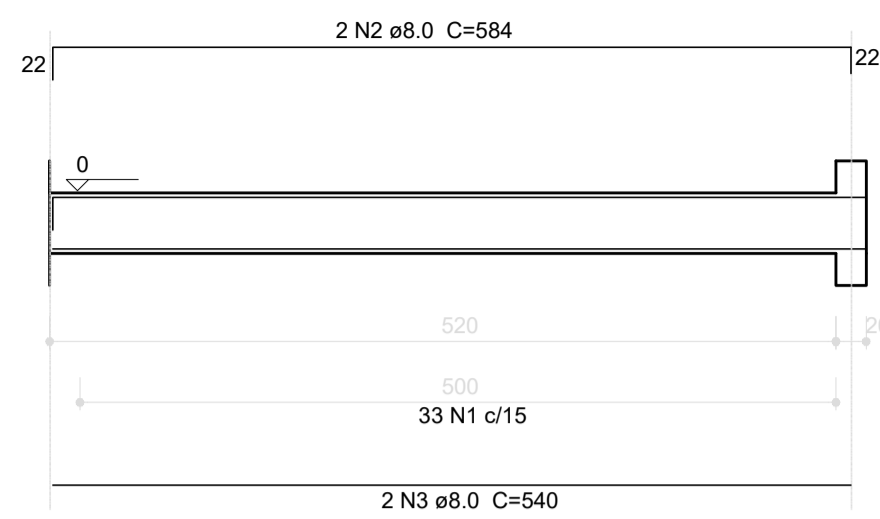

V2 = V5=V11=V14  
ESC 1:50

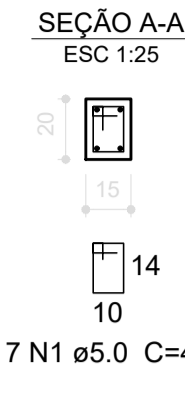
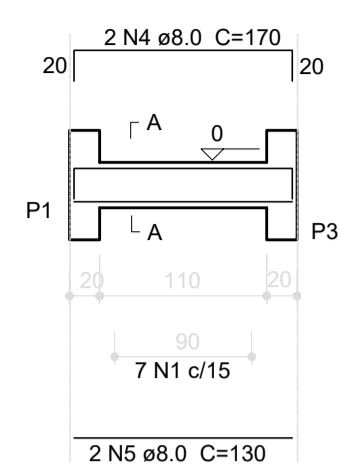

V3=V4=V6=V7=V12=V13=V15=V16  
ESC 1:50

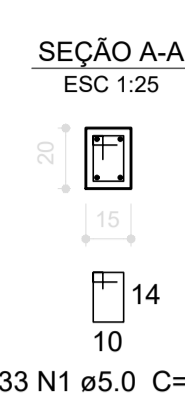
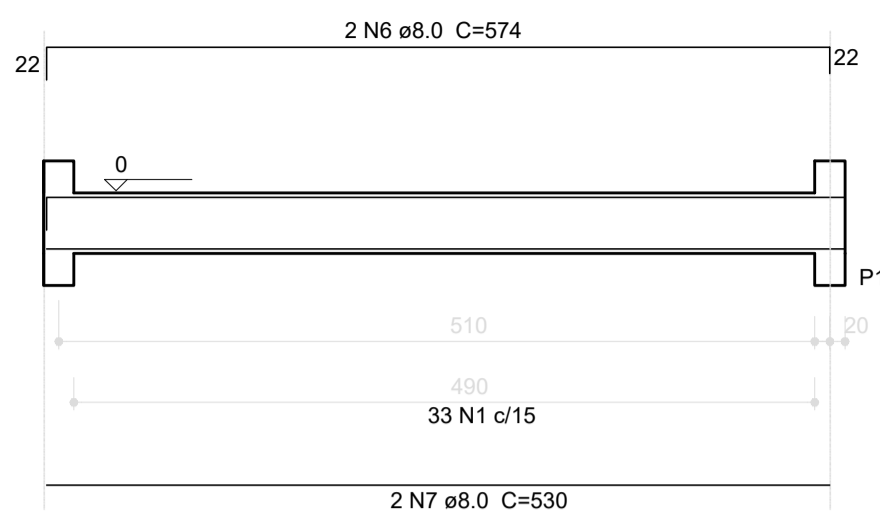

V8 = V17  
ESC 1:50

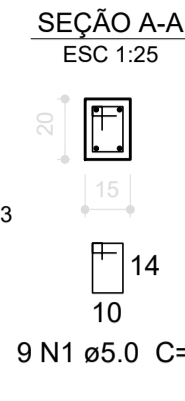
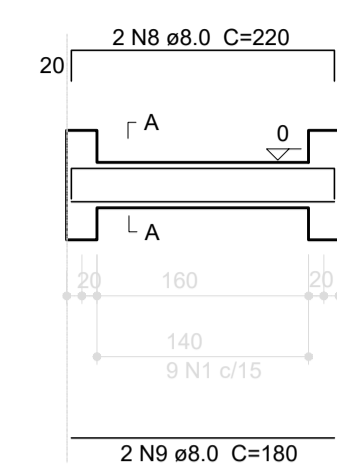

V9 = V18  
ESC 1:50

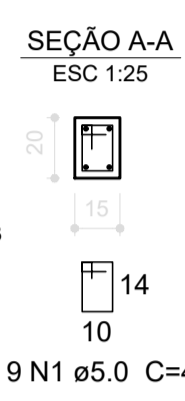
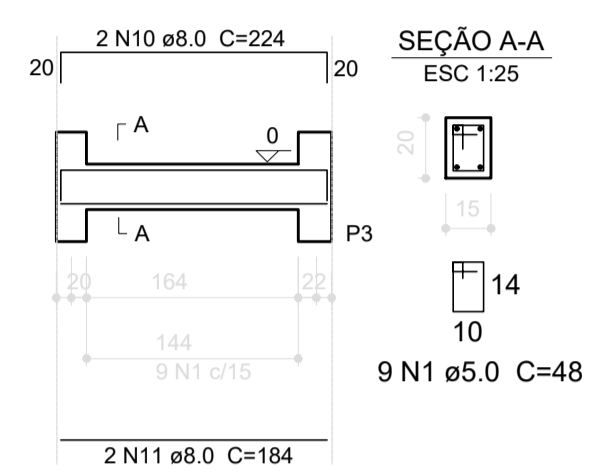

V19 = V20=V21=V22=V23=V24=V25=V26=V27=V28  
ESC 1:50

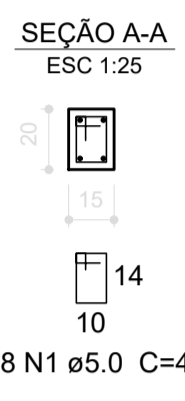
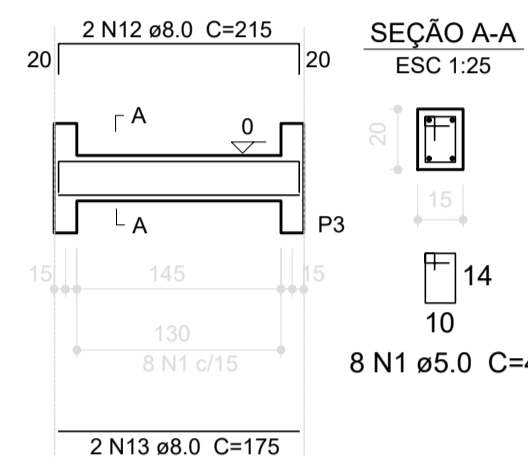

Relação do aço

AÇO	N	DIAM (mm)	QUANT (Barras)	UNIT (cm)	C.TOTAL (cm)
CA60	1	5.0	474	48	22752
CA50	2	8.0	4	584	2336
	3	8.0	4	540	2160
	4	8.0	8	170	1360
	5	8.0	8	130	1040
	6	8.0	16	574	9184
	7	8.0	16	530	8480
	8	8.0	4	220	880
	9	8.0	16	180	720
	10	8.0	4	224	896
	11	8.0	4	184	736
	12	8.0	20	215	4300
	13	8.0	20	175	3500

Resumo do aço

AÇO	DIAM (mm)	C.TOTAL (m)	PESO (kg)
CA50	8.0	355.9	140.6
CA60	5.0	227.5	35.1
PESO TOTAL (kg)			
CA50	140.6		
CA60	35.1		

Volume de concreto (C-25) = 2.15 m³  
Área de forma = 14.35 m²

01 DETALHAMENTO VIGAS BALDRAME  
ESCALA: INDICADA

V1=V10  
ESC 1:50

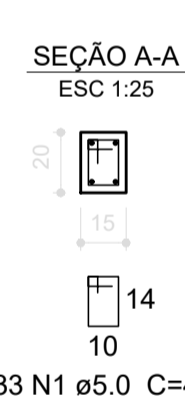
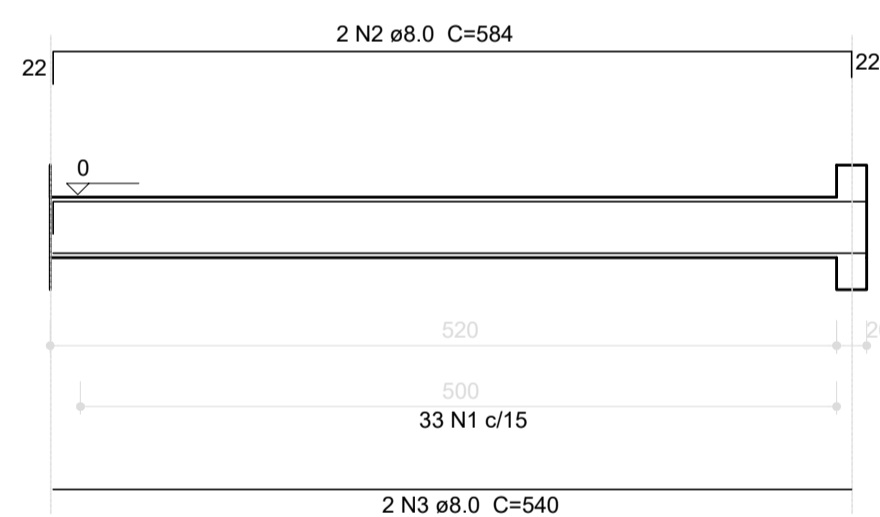

V2 = V5=V11=V14  
ESC 1:50

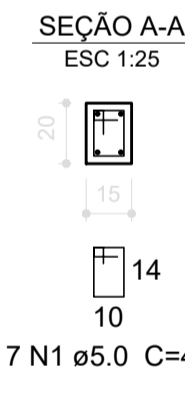
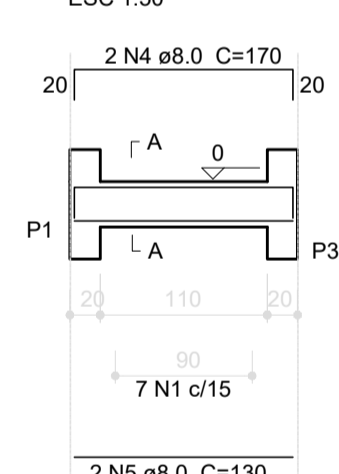

V3=V4=V6=V7=V12=V13=V15=V16  
ESC 1:50

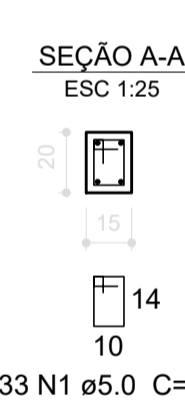
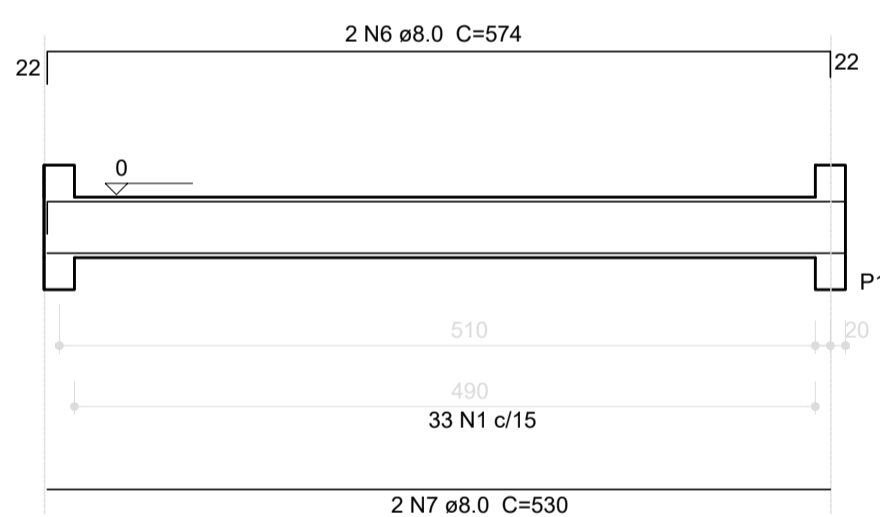

V8 = V17  
ESC 1:50

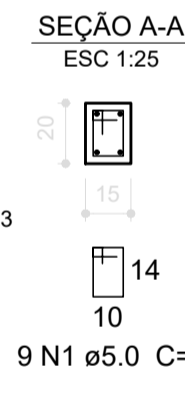
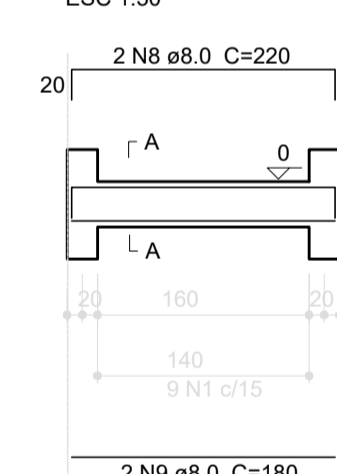

V9 = V18  
ESC 1:50

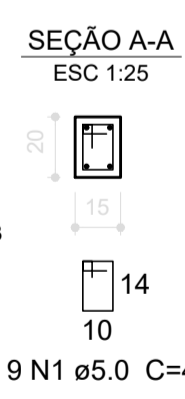
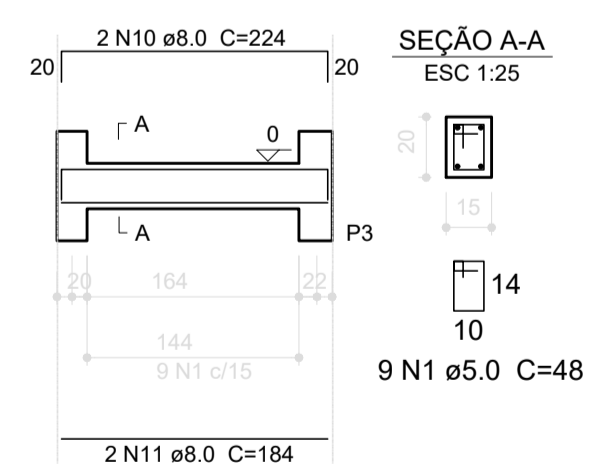

V19 = V20=V21=V22=V23=V24=V25=V26=V27=V28  
ESC 1:50

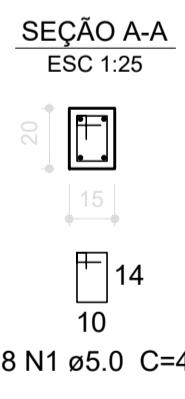
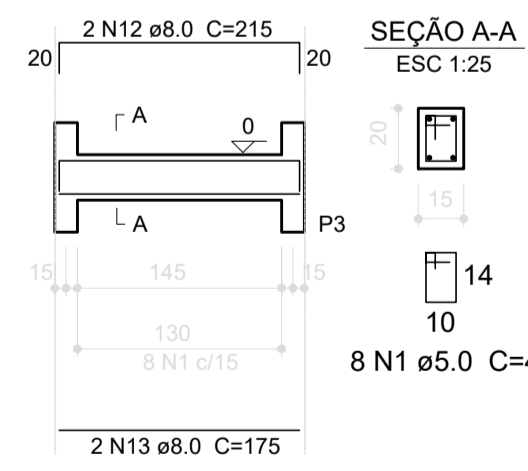

Relação do aço

AÇO	N	DIAM (mm)	QUANT (Barras)	UNIT (cm)	C.TOTAL (cm)
CA60	1	5.0	474	48	22752
CA50	2	8.0	4	584	2336
	3	8.0	4	540	2160
	4	8.0	8	170	1360
	5	8.0	8	130	1040
	6	8.0	16	574	9184
	7	8.0	16	530	8480
	8	8.0	4	220	880
	9	8.0	16	180	720
	10	8.0	4	224	896
	11	8.0	4	184	736
	12	8.0	20	215	4300
	13	8.0	20	175	3500

Resumo do aço

AÇO	DIAM (mm)	C.TOTAL (m)	PESO (kg)
CA50	8.0	355.9	140.6
CA60	5.0	227.5	35.1
PESO TOTAL (kg)			
CA50	140.6		
CA60	35.1		

Volume de concreto (C-25) = 2.15 m³  
Área de forma = 25.11 m²

02 DETALHAMENTO VIGAS DE COBERTURA  
ESCALA: INDICADA

ID Nº 1117659 ESCOLA 2 SALAS

ENDEREÇO: PARECI NOVO, RS, EMEF CATHARINA F. WEISSHEIMER  
MUNICÍPIO - UF: PARECI NOVO, RS  
PREFEITURA MUNICIPAL DE PARECI NOVO, RS  
PROPRIETÁRIO  
RESP. TÉCNICO CREA/CAU

OBSERVAÇÕES: ART

PROJETO DE ESTRUTURA

PROJETO ESTRUTURAL  
RAMPA

EST.

FORMATO A1 (840X594)  
REVISÃO R.00 INDICADA  
ESCALA INDICADA  
DATA EMISSÃO 24/10/2025  
PRANCHA 03/03